

### 3.1 GTO Snubber Capacitors :

STG series

#### Applications :

GTO Snubbing and protection, Thyristor controlled rectifier circuits, High Current Snubber circuit, damping of voltage spikes on GTO-Thyristor.

Traction application and Static Drive, Pulsed Lasers, Medium Frequency tuning High ripple current and high dv/dt application.

#### Properties :

Very Low ESR, medium frequency range, High RMS Current Rating, High Pulse Current Rating dv/dt, High Voltage Capabilities, Temperature up to 105C, High Insulation Resistance and Flame Retardant Construction

#### Electrical Characteristics :

Rated Voltage : 400Vndc – 5,800Vndc / 160Vrms – 2,000Vrms  
Capacitance range : 0.15 - 220uF ( can be customized )

Ripple RMS Current up to 80A

#### Other Electrical Characteristics :

Capacitance Tolerance : +/-5%; +/-10%

Operating Temperature : +45C / +55C / +70C / +85C / +105C  
( depends on capacitor raw materials )

Testing Voltage Terminal to Terminal : Vsurge 10 sec ( can be customized )

Testing Voltage Terminal to Case : 4500Vac at 105C 1min.  
Support higher voltage requirement

Insulation Resistance :250Vdc +25C >= 300,000Mohm  
250Vdc +85C >= 50,000Mohm  
250Vdc +105C >= 5,000Mohm

Ultra-Low Leakage version is available on request

Reference Standard : IEC61071

#### Specifications and Size :

**STG-A Vndc = 400V / Vrms = 160Vac / Vpeak = 230V 10s / Vsurge = 650V 30s/day**

P/N :	Cn uF	Diameter D mm	Length L mm	ESR mohm 100khz	ESL nH	dv/dt v/us	Peak Current I <sub>peak</sub> A	Max. Amp 70C	Max. Amp 85C	d (mm)
STG-A336J400D	33	65	58	2.2	38	25	800	45	21	M6
STG-A506J400D	50	90	58	1.8	38	25	1200	60	27	M8
STG-A756J400D	75	90	58	1.5	38	25	1800	70	33	M8
STG-A107J400D	100	90	58	1.6	38	25	2500	70	31	M8
STG-A117J400D	110	90	58	1.6	38	25	2700	70	34	M8
STG-A227J400D	220	90	96	1.9	80	12	2600	70	31	M8

**STG-A Vndc = 600V / Vrms = 220Vac / Vpeak = 310V 10s / Vsurge = 900V 30s/day**

P/N :	Cn uF	Diameter D mm	Length L mm	ESR mohm 100khz	ESL nH	dv/dt v/us	Peak Current I <sub>peak</sub> A	Max. Amp 70C	Max. Amp 85C	d (mm)
STG-A336J600D	33	90	58	1.7	38	50	1600	47	25	M8
STG-A506J600D	50	90	58	1.6	38	50	2500	62	33	M8
STG-A107J600D	100	90	96	2.5	80	22	2200	57	30	M8

**STG-A Vndc = 700V / Vrms = 250Vac / Vpeak = 350V 10s / Vsurge = 1100V 30s/day**

P/N :	Cn uF	Diameter D mm	Length L mm	ESR mohm 100khz	ESL nH	dv/dt v/us	Peak Current I <sub>peak</sub> A	Max. Amp 70C	Max. Amp 85C	D (mm)
STG-A206J700D	20	90	58	1.7	38	60	1200	46	35	M6
STG-A256J700D	25	90	58	1.6	38	60	1500	58	43	M8
STG-A336J700D	33	90	58	1.4	38	60	2000	62	47	M8
STG-A506J700D	50	90	96	2.6	80	25	1200	48	36	M8

**STG-01A Vndc = 700V / Vrms = 250Vac / Vpeak = 360V 10s / Vsurge = 1000V 30s/day**

P/N :	Cn uF	Diameter D mm	Length L mm	ESR mohm 100khz	ESL nH	dv/dt v/us	Peak Current I <sub>peak</sub> A	Max. Amp 70C	Max. Amp 85C	Max. Amp 105C	d (mm)
STG-01A126K700D	12	90	63.5	2.6	10	320	3800	60	55	40	M6
STG-01A156K700D	15	90	63.5	2.5	10	320	4800	60	55	40	M6
STG-01A206K700D	20	90	81	2.6	12	190	3800	60	55	40	M6
STG-01A226K700D	22	90	81	2.4	12	190	4200	60	55	40	M6
STG-01A256K700D	25	90	99	2.7	15	130	3300	60	55	40	M6
STG-01A306K700D	30	90	99	2.5	15	130	4000	60	55	40	M6
STG-01A356K700D	35	90	99	2.2	15	130	4600	60	55	40	M6
STG-01A406K700D	40	90	134	2.4	22	80	3400	60	55	40	M6
STG-01A456K700D	45	90	134	2.2	22	80	3900	70	65	45	M6
STG-01A506K700D	50	90	134	2.1	22	80	4300	70	65	45	M6

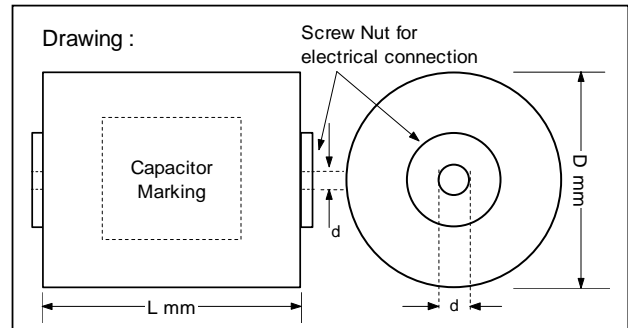
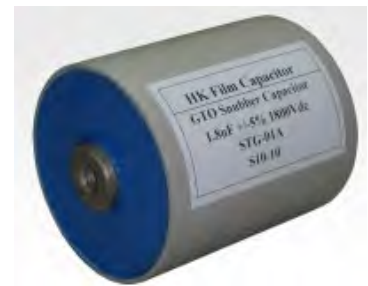

**STG-01A V<sub>ndc</sub> = 850V / V<sub>rms</sub> = 320Vac / V<sub>peak</sub> = 450V 10s / V<sub>surge</sub> = 1300V 30s/day**

P/N :	C <sub>n</sub> uF	Diameter D mm	Length L mm	ESR mohm 100khz	ESL nH	dv/dt v/us	Peak Current I <sub>peak</sub> A	Max. Amp 45C	Max. Amp 55C	Max. Amp 70C	Max. Amp 85C	d (mm)
STG-01A205J850D	2	65	50	1.5	11	800	1600	38	30	20	12	M6
STG-01A225J850D	2.2	65	50	1.5	11	800	1700	40	35	23	13	M6
STG-01A255J850D	2.5	65	50	1.2	11	800	2000	45	38	25	15	M6
STG-01A305J850D	3	65	50	1.2	11	800	2400	55	45	30	18	M6
STG-01A405J850D	4	65	50	1.0	11	800	3200	70	60	40	25	M6
STG-01A505J850D	5	65	50	1.0	11	800	4000	80	70	50	30	M6
STG-01A605J850D	6	65	62	1.0	15	440	2600	60	50	35	20	M6
STG-01A805J850D	8	65	62	0.8	15	440	3500	80	70	45	25	M6

**STG-A V<sub>ndc</sub> = 850V / V<sub>rms</sub> = 330Vac / V<sub>peak</sub> = 470V 10s / V<sub>surge</sub> = 1300V 30s/day**

P/N :	C <sub>n</sub> uF	Diameter D mm	Length L mm	ESR mohm 100khz	ESL nH	dv/dt v/us	Peak Current I <sub>peak</sub> A	Max. Amp 70C	Max. Amp 85C	Max. Amp 105C	d (mm)
STG-A256J850D	25	90	62	1.6	38	80	2000	65	49	35	M6
STG-A606J850D	60	90	92	2.5	80	30	1800	56	42	30	M6

**STG-01A V<sub>ndc</sub> = 900V / V<sub>rms</sub> = 280Vac / V<sub>peak</sub> = 400V 10s / V<sub>surge</sub> = 1440V 10s/day**

P/N :	C <sub>n</sub> uF	Diameter D mm	Length L mm	ESR mohm 100khz	ESL nH	dv/dt v/us	Peak Current I <sub>peak</sub> A	Max. Amp 70C	Max. Amp 85C	Max. Amp 105C	d (mm)
STG-01A225J900D	2.2	65	100	2.2	20	720	1500	35	30	10	M6
STG-01A335J900D	3.3	65	100	2.4	20	400	1300	30	25	9	M6
STG-01A475J900D	4.7	65	100	2.3	20	400	1900	35	30	10	M6
STG-01A685J900D	6.8	90	100	2.0	20	300	2000	40	35	15	M6
STG-01A106J900D	10	90	100	1.9	20	300	3000	45	50	17	M8
STG-01A156J900D	15	90	100	1.7	20	250	3700	50	50	17	M8
STG-01A226K900D	22	90	165	2.0	25	250	5500	60	55	25	M8
STG-01A336K900D	33	90	225	2.0	30	250	8200	80	60	30	M8
STG-01A406K900D-V1	40	90	225	1.7	30	250	10000	80	70	40	M8
STG-01A506K900D	50	90	293	1.9	40	250	12500	80	70	40	M8
STG-01A606K900D	60	90	293	1.7	40	250	15000	80	70	40	M8

**STG-01A V<sub>ndc</sub> = 900V / V<sub>rms</sub> = 320Vac / V<sub>peak</sub> = 450V 10s / V<sub>surge</sub> = 1260V 30s/day**

P/N :	C <sub>n</sub> uF	Diameter D mm	Length L mm	ESR mohm 100khz	ESL nH	dv/dt v/us	Peak Current I <sub>peak</sub> A	Max. Amp 70C	Max. Amp 85C	Max. Amp 105C	d (mm)
STG-01A805K900D	8	65	81	2.8	12	280	2200	45	40	30	M6
STG-01A106K900D	10	65	81	2.7	12	280	2800	45	40	30	M6
STG-01A126K900D	12	65	99	2.6	15	190	2300	45	40	30	M6
STG-01A156K900D	15	65	99	2.5	15	190	2900	50	45	35	M6
STG-01A186K900D	18	90	99	2.4	15	190	3500	50	45	35	M6
STG-01A206K900D	20	65	134	2.5	22	120	2500	50	45	35	M6
STG-01A256K900D	25	90	134	2.4	22	120	3100	60	55	40	M6
STG-01A306K900D	30	90	134	2.3	22	120	3800	70	65	50	M6
STG-01A356K900D	35	90	134	2.2	22	120	4400	70	65	50	M6
STG-01A406K900D-V2	40	90	134	2.1	22	120	5000	70	65	50	M6

**STG-01A V<sub>ndc</sub> = 1000V / V<sub>rms</sub> = 300Vac / V<sub>peak</sub> = 450V 10s / V<sub>surge</sub> = 1600V 10s/day**

P/N :	C <sub>n</sub> uF	Diameter D mm	Length L mm	ESR mohm 100khz	ESL nH	dv/dt v/us	Peak Current I <sub>peak</sub> A	Max. Amp 70C	Max. Amp 85C	Max. Amp 105C	d (mm)
STG-01A225J1000D	2.2	65	100	2.2	20	880	1900	35	30	13	M6
STG-01A335J1000D	3.3	65	100	2.4	20	490	1600	30	25	11	M6
STG-01A475J1000D	4.7	65	100	2.0	20	490	2300	40	35	15	M6
STG-01A685J1000D	6.8	90	100	2.0	20	400	2700	40	40	18	M6
STG-01A755J1000D	7.5	90	100	1.7	20	400	3000	45	45	20	M8
STG-01A106J1000D	10	90	100	1.7	20	300	3000	45	45	20	M8
STG-01A126K1000D	12	90	165	1.9	29	300	3600	50	45	20	M8
STG-01A156K1000D	15	90	165	1.9	29	300	4500	60	50	25	M8
STG-01A226K1000D	22	90	165	1.7	35	300	6600	70	60	30	M8
STG-01A256K1000D	25	90	225	1.9	23	300	7500	80	55	25	M8
STG-01A306K1000D	30	90	225	1.7	23	300	9000	80	60	30	M8
STG-01A336K1000D	33	90	225	1.7	23	300	9900	80	70	35	M8
STG-01A356K1000D	35	90	293	1.9	18	300	10500	80	70	35	M8
STG-01A406K1000D	40	90	293	1.7	18	300	12000	80	70	35	M8

For other Capacitance, Voltage, dv/dt, Peak Current and RMS Current not listed, please contact us for a suggestion.

**STG-01A V<sub>ndc</sub> = 1100V / V<sub>rms</sub> = 370Vac / V<sub>peak</sub> = 525V 10s / V<sub>surge</sub> = 1680V 10s/day**

P/N :	C <sub>n</sub> uF	Diameter D mm	Length L mm	ESR mohm 100khz	ESL nH	dv/dt v/us	Peak Current I <sub>peak</sub> A	Max. Amp 70C	Max. Amp 85C	Max. Amp 105C	d (mm)
STG-01A605K1100D	6	65	81	2.7	12	420	2500	45	40	30	M6
STG-01A805K1100D	8	90	81	2.5	12	420	3400	55	50	40	M6
STG-01A106K1100D	10	90	81	2.2	12	420	4200	70	65	55	M6
STG-01A126K1100D	12	90	99	2.2	15	290	3502	70	65	55	M6
STG-01A156K1100D	15	90	134	2.4	22	190	2800	50	45	35	M6
STG-01A186K1100D	18	90	134	2.3	22	190	3400	55	50	40	M6
STG-01A206K1100D	20	90	134	2.2	22	190	3800	65	60	45	M6
STG-01A226K1100D	22	90	134	2.1	22	190	4200	70	65	50	M6
STG-01A256K1100D	25	90	134	1.9	22	190	4800	70	65	50	M6

**STG-01A V<sub>ndc</sub> = 1200V / V<sub>rms</sub> = 390Vac / V<sub>peak</sub> = 550V 10s / V<sub>surge</sub> = 1800V 30s/day**

P/N :	C <sub>n</sub> uF	Diameter D mm	Length L mm	ESR mohm 100khz	ESL nH	dv/dt v/us	Peak Current I <sub>peak</sub> A	Max. Amp 45C	Max. Amp 55C	Max. Amp 70C	Max. Amp 85C	d (mm)
STG-01A105J1200D	1	65	50	1.6	11	1200	1200	30	25	16.5	10	M6
STG-01A155J1200D	1.5	65	50	1.5	11	1200	1800	45	35	25	15	M6
STG-01A205J1200D	2	65	50	1.2	11	1200	2400	60	50	33	18	M6
STG-01A225J1200D	2.2	65	50	1.2	11	1200	2600	65	55	35	20	M6
STG-01A255J1200D	2.5	65	62	1.2	15	620	1500	70	35	23	13	M6
STG-01A305J1200D	3	65	62	1.0	15	620	1800	50	40	27	16	M6
STG-01A355J1200D	3.5	65	62	1.0	15	620	2100	55	45	30	18	M6
STG-01A405J1200D	4	65	62	0.8	15	620	2400	65	55	35	22	M6

**STG-01A V<sub>ndc</sub> = 1200V / V<sub>rms</sub> = 390Vac / V<sub>peak</sub> = 550V 10s / V<sub>surge</sub> = 1950V 30s/day**

P/N :	C <sub>n</sub> uF	Diameter D mm	Length L mm	ESR mohm 100khz	ESL nH	dv/dt v/us	Peak Current I <sub>peak</sub> A	Max. Amp 85C	Max. Amp 105C	d (mm)
STG-01A205K1200D-C6x	2	65	120	2.4	34.2	1220	2400	25	16.5	M6
STG-01A255K1200D-C6x	2.5	65	130	2.3	34.2	1220	3000	35	20	M6
STG-01A335K1200D-C6x	3.3	65	160	1.8	22.8	1220	4000	35	20	M6
STG-01A355K1200D-C6x	3.5	65	165	1.7	22.8	1220	4200	35	20	M6
STG-01A405K1200D-C6x	4	65	145	2.2	22.8	680	2700	25	15	M6
STG-01A505K1200D-C6x	5	65	215	1.9	17.1	1220	6100	50	30	M6
STG-01A605K1200D-C6x	6	65	185	2.1	17.1	680	4000	35	20	M6
STG-01A805K1200D-C6x	8	90	165	2.0	22.8	520	4100	40	23	M6
STG-01A106K1200D-C6x	10	90	180	1.9	22.8	520	5200	60	28	M8
STG-01A126K1200D-C6x	12	90	190	1.8	22.8	520	6200	60	35	M8
STG-01A156K1200D-C6x	15	90	245	1.8	17.1	520	7800	60	35	M8
STG-01A106K1200D-C6x	18	90	245	1.9	17.1	400	7200	60	35	M8
STG-01A106K1200D-C6x	20	90	245	1.8	17.1	400	8000	60	40	M8
STG-01A106K1200D-C6x	22	90	245	1.7	17.1	400	8800	60	40	M8

**STG-A V<sub>ndc</sub> = 1200V / V<sub>rms</sub> = 440Vac / V<sub>peak</sub> = 630V 10s / V<sub>surge</sub> = 1800V 30s/day**

P/N :	C <sub>n</sub> uF	Diameter r D mm	Length L mm	ESR mohm 100khz	ESL nH	dv/dt v/us	Peak Current I <sub>peak</sub> A	Max. Amp 70C	Max. Amp 85C	d (mm)
STG-A255J1200D	2.5	65	58	1.8	25	300	750	45	40	M8
STG-A305J1200D	3	65	58	1.7	25	300	900	50	46	M8
STG-A505J1200D	5	90	58	1.6	25	300	1500	70	53	M8
STG-A605J1200D	6	90	58	1.5	25	300	1800	70	64	M8

**STG-01A V<sub>ndc</sub> = 1300V / V<sub>rms</sub> = 400Vac / V<sub>peak</sub> = 580V 10s / V<sub>surge</sub> = 2100V 10s/day**

P/N :	C <sub>n</sub> uF	Diameter D mm	Length L mm	ESR mohm 100khz	ESL nH	dv/dt v/us	Peak Current I <sub>peak</sub> A	Max. Amp 70C	Max. Amp 85C	Max. Amp 105C	d (mm)
STG-01A225J1300D	2.2	65	100	2.3	20	680	1500	30	20	12	M6
STG-01A335J1300D	3.3	90	100	1.7	20	520	1700	40	30	14	M8
STG-01A475J1300D	4.7	90	100	1.8	20	520	2400	45	30	20	M8
STG-01A685J1300D	6.8	90	165	2.2	25	520	3500	50	35	20	M8
STG-01A755K1300D	7.5	90	165	1.9	29	520	3900	50	40	20	M8
STG-01A106K1300D	10	90	165	1.9	35	400	4000	55	40	20	M8
STG-01A126K1300D	12	90	165	1.7	35	400	4800	60	45	25	M8
STG-01A156K1300D	15	90	225	1.9	23	400	6000	70	45	25	M8
STG-01A206K1300D	20	90	293	1.9	18	400	8000	80	60	30	M8
STG-01A226K1300D	22	90	293	1.7	18	400	8800	80	60	30	M8
STG-01A256K1300D	25	90	293	1.7	18	400	10000	80	70	35	M8

For other Capacitance, Voltage, dv/dt, Peak Current and RMS Current not listed, please contact us for a suggestion.

**STG-A V<sub>ndc</sub> = 1400V / V<sub>rms</sub> = 500Vac / V<sub>peak</sub> = 700V 10s / V<sub>surge</sub> = 2100V 30s/day**

P/N :	C <sub>n</sub> uF	Diameter D mm	Length L mm	ESR mohm 100khz	ESL nH	dv/dt v/us	Peak Current I <sub>peak</sub> A	Max. Amp 55C	Max. Amp 70C	Max. Amp 85C	d (mm)
STG-A225J1400D	2.2	65	56	2.0	8.5	530	1100	33	28	23	M6
STG-A255J1400D	2.5	65	56	1.8	8.5	530	1300	37	32	27	M6
STG-A305J1400D	3	65	56	1.8	8.5	530	1600	37	32	25	M6
STG-A405J1400D	4	65	56	1.5	8.5	530	2100	45	40	33	M6
STG-A505J1400D	5	90	56	1.4	8.5	530	2600	60	50	40	M6
STG-A605J1400D	6	90	56	1.2	8.5	530	3200	70	60	50	M8
STG-A705J1400D	7	90	56	1.1	8.5	530	3700	70	60	50	M8
STG-A805J1400D	8	90	56	0.9	8.5	530	4200	70	60	50	M8

**STG-01A V<sub>ndc</sub> = 1500V / V<sub>rms</sub> = 450Vac / V<sub>peak</sub> = 640V 10s / V<sub>surge</sub> = 2400V 10s/day**

P/N :	C <sub>n</sub> uF	Diameter D mm	Length L mm	ESR mohm 100khz	ESL nH	dv/dt v/us	Peak Current I <sub>peak</sub> A	Max. Amp 70C	Max. Amp 85C	Max. Amp 105C	d (mm)
STG-01A225J1500D	2.2	90	100	1.9	20	660	1400	35	30	7	M6
STG-01A335J1500D	3.3	90	100	1.7	20	660	2100	40	35	8	M6
STG-01A405J1500D	4	90	100	1.7	20	500	2000	40	35	8	M6
STG-01A455J1500D	4.5	90	100	1.7	20	500	2200	45	35	9	M8
STG-01A685K1500D	6.8	90	165	1.7	29	500	3400	55	50	14	M8
STG-01A755K1500D	7.5	90	165	1.8	35	500	3700	55	45	14	M8
STG-01A106K1500D-V1	10	90	225	1.8	23	500	5000	70	60	18	M8
STG-01A126K1500D-V1	12	90	225	1.7	23	500	6000	70	55	18	M8
STG-01A156K1500D-V1	15	90	293	1.8	18	500	7500	80	60	20	M8
STG-01A186K1500D	18	90	293	1.7	18	500	9000	80	70	20	M8

**STG-01A V<sub>ndc</sub> = 1500V / V<sub>rms</sub> = 400Vac / V<sub>peak</sub> = 570V 10s / V<sub>surge</sub> = 2100V 10s/day**

P/N :	C <sub>n</sub> uF	Diameter D mm	Length L mm	ESR mohm 100khz	ESL nH	dv/dt v/us	Peak Current I <sub>peak</sub> A	Max. Amp 70C	Max. Amp 85C	Max. Amp 105C	d (mm)
STG-01A405K1500D	4	65	81	2.7	12	694	2776	40	30	20	M6
STG-01A505K1500D	5	90	81	2.5	12	694	3470	40	30	20	M6
STG-01A605K1500D	6	65	99	2.7	15	480	2880	40	30	20	M6
STG-01A805K1500D	8	90	99	2.4	15	480	3840	55	45	35	M6
STG-01A106K1500D-V2	10	90	99	2.2	15	480	4800	70	60	50	M6
STG-01A126K1500D-V2	12	90	134	2.4	22	312	3744	55	45	35	M6
STG-01A156K1500D-V2	15	90	134	2.1	22	312	4680	70	60	50	M6

**STG-01A V<sub>ndc</sub> = 1500V / V<sub>rms</sub> = 450Vac / V<sub>peak</sub> = 636V 10s / V<sub>surge</sub> = 2400V 30s/day**

P/N :	C <sub>n</sub> uF	Diameter D mm	Length L mm	ESR mohm 100khz	ESL nH	dv/dt v/us	Peak Current I <sub>peak</sub> A	Max. Amp 85C	Max. Amp 105C	d (mm)
STG-01A155K1500D-C6x	1.5	65	125	1.9	34.2	1500	2200	25	15	M6
STG-01A205K1500D-C6x	2	65	110	2.3	34.2	850	1700	25	15	M6
STG-01A255K1500D-C6x	2.5	65	165	1.9	22.8	1500	3700	35	25	M6
STG-01A305K1500D-C6x	3	65	145	2.3	22.8	850	2500	30	20	M6
STG-01A405K1500D-C6x	4	65	180	2.3	17.1	850	3400	30	20	M6
STG-01A505K1500D-C6x	5	90	160	1.9	22.8	660	3300	40	25	M6
STG-01A605K1500D-C6x	6	90	170	1.9	22.8	660	3960	40	25	M6
STG-01A805K1500D-C6x	8	90	195	1.7	22.8	660	5280	50	35	M6
STG-01A106K1500D-C6x	10	90	255	1.8	17.1	660	6600	60	40	M8
STG-01A126K1500D-C6x	12	90	255	1.7	17.1	660	7900	60	40	M8

**STG-A V<sub>ndc</sub> = 1500V / V<sub>rms</sub> = 500Vac / V<sub>peak</sub> = 700V 10s / V<sub>surge</sub> = 2300V 30s/day**

P/N :	C <sub>n</sub> uF	Diameter D mm	Length L mm	ESR mohm 100khz	ESL nH	dv/dt v/us	Peak Current I <sub>peak</sub> A	Max. Amp 70C	Max. Amp 85C	d (mm)
STG-A305J1500D	3	65	58	1.5	25	450	1300	47	33	M6
STG-A405J1500D	4	90	58	1.3	25	450	1800	63	44	M8

**STG-01A V<sub>ndc</sub> = 1600V / V<sub>rms</sub> = 600Vac / V<sub>peak</sub> = 850V 10s / V<sub>surge</sub> = 2400V 30s/day**

P/N :	C <sub>n</sub> uF	Diameter D mm	Length L mm	ESR mohm 100khz	ESL nH	dv/dt v/us	Peak Current I <sub>peak</sub> A	Max. Amp 45C	Max. Amp 55C	Max. Amp 70C	Max. Amp 85C	d (mm)
STG-01A684J1600D	0.68	65	50	1.6	11	1500	1000	25	21	14	8	M6
STG-01A105J1600D	1	65	50	1.5	11	1500	1500	35	30	20	12	M6
STG-01A125J1600D	1.2	65	50	1.5	11	1500	1800	45	35	25	15	M6
STG-01A155J1600D	1.5	65	50	1.5	11	1500	2200	55	45	30	18	M6
STG-01A205J1600D	2	65	62	1.2	15	840	1600	40	35	23	13	M6
STG-01A225J1600D	2.2	65	62	1.2	15	840	1800	45	35	25	15	M6
STG-01A255J1600D	2.5	65	62	1.0	15	840	2100	50	40	27	16	M6

For other Capacitance, Voltage, dv/dt, Peak Current and RMS Current not listed, please contact us for a suggestion.

**STG-01A V<sub>ndc</sub> = 1700V / V<sub>rms</sub> = 530Vac / V<sub>peak</sub> = 750V 10s / V<sub>surge</sub> = 2720V 30s/day**

P/N :	C <sub>n</sub> uF	Diameter D mm	Length L mm	ESR mohm 100khz	ESL nH	dv/dt v/us	Peak Current I <sub>peak</sub> A	Max. Amp 70C	Max. Amp 85C	Max. Amp 105C	d (mm)
STG-01A225K1700D	2.2	65	80	1.2	25	1200	2600	50	40	15	M6
STG-01A255K1700D	2.5	65	105	1.3	35	680	1700	50	40	15	M6
STG-01A305K1700D	3	65	105	1.5	35	680	2040	50	40	20	M6
STG-01A405K1700D	4	65	120	1.5	40	520	2080	50	40	20	M6
STG-01A505K1700D	5	65	140	1.5	50	400	2000	50	40	20	M6
STG-01A605K1700D	6	65	140	1.3	50	400	2400	60	50	25	M6

**STG-01A V<sub>ndc</sub> = 1700V / V<sub>rms</sub> = 530Vac / V<sub>peak</sub> = 740V 10s / V<sub>surge</sub> = 2700V 30s/day**

P/N :	C <sub>n</sub> uF	Diameter D mm	Length L mm	ESR mohm 100khz	ESL nH	dv/dt v/us	Peak Current I <sub>peak</sub> A	Max. Amp 85C	Max. Amp 105C	d (mm)
STG-01A105K1800D-C6x	1	65	120	2.3	34.2	1800	1800	25	15	M6
STG-01A125K1800D-C6x	1.2	65	130	2.2	34.2	1800	2100	25	15	M6
STG-01A155K1800D-C6x	1.5	65	160	2.3	22.8	1800	2700	25	15	M6
STG-01A205K1800D-C6x	2	65	145	2.5	22.8	1040	2000	25	15	M6
STG-01A255K1800D-C6x	2.5	65	220	2.2	17.1	1800	4500	40	25	M6
STG-01A305K1800D-C6x	3	65	185	2.6	17.1	1040	3100	40	25	M6
STG-01A355K1800D-C6x	3.5	90	140	2.0	34.2	800	2800	40	25	M6
STG-01A405K1800D-C6x	4	90	145	1.9	34.2	800	3200	40	25	M6
STG-01A505K1800D-C6x	5	90	180	2.0	22.8	800	4000	40	25	M6
STG-01A605K1800D-C6x	6	90	200	1.8	22.8	800	4800	50	30	M6
STG-01A805K1800D-C6x	8	90	200	1.7	22.8	800	6400	50	30	M6
STG-01A106K1800D-C6x	10	90	250	1.8	17.1	800	8000	50	30	M6

**STG-A V<sub>ndc</sub> = 1700V / V<sub>rms</sub> = 650Vac / V<sub>peak</sub> = 920V 10s / V<sub>surge</sub> = 2600V 30s/day**

P/N :	C <sub>n</sub> uF	Diameter D mm	Length L mm	ESR mohm 100khz	ESL nH	dv/dt v/us	Peak Current I <sub>peak</sub> A	Max. Amp 55C	Max. Amp 70C	Max. Amp 85C	d (mm)
STG-A205J1700D	2	65	56	1.9	8.5	845	1700	30	25	21	M6
STG-A225J1700D	2.2	65	56	1.7	8.5	845	1800	33	28	23	M6
STG-A255J1700D	2.5	65	56	1.5	8.5	845	2100	37	32	27	M6
STG-A305J1700D	3	65	56	1.3	8.5	845	2500	45	39	32	M6
STG-A405J1700D	4	90	56	1.1	8.5	845	3300	60	50	40	M6
STG-A505J1700D	5	90	56	1.0	8.5	845	4200	70	60	50	M8

**STG-01A V<sub>ndc</sub> = 1800V / V<sub>rms</sub> = 540Vac / V<sub>peak</sub> = 760V 10s / V<sub>surge</sub> = 2900V 10s/day**

P/N :	C <sub>n</sub> uF	Diameter D mm	Length L mm	ESR mohm 100khz	ESL nH	dv/dt v/us	Peak Current I <sub>peak</sub> A	Max. Amp 70C	Max. Amp 85C	Max. Amp 105C	d (mm)
STG-01A225J1800D	2.2	90	100	1.9	20	800	1700	35	30	15	M6
STG-01A335K1800D	3.3	90	165	2.5	29	800	2600	45	30	17	M8
STG-01A475K1800D	4.7	90	165	2.0	35	620	2900	45	30	17	M8
STG-01A685K1800D	6.8	90	225	2.0	23	620	4200	55	35	20	M8
STG-01A805K1800D-V1	8	90	225	1.8	23	620	4900	55	40	25	M8
STG-01A106K1800D-V1	10	90	293	1.8	18	620	6200	80	45	30	M8
STG-01A126K1800D-V1	12	90	293	1.7	18	620	7400	80	60	35	M8

**STG-01A V<sub>ndc</sub> = 1800V / V<sub>rms</sub> = 440Vac / V<sub>peak</sub> = 625V 10s / V<sub>surge</sub> = 2520V 10s/day**

P/N :	C <sub>n</sub> uF	Diameter D mm	Length L mm	ESR mohm 100khz	ESL nH	dv/dt v/us	Peak Current I <sub>peak</sub> A	Max. Amp 70C	Max. Amp 85C	Max. Amp 105C	d (mm)
STG-01A405K1800D	4	65	99	2.7	15	690	2700	35	30	20	M6
STG-01A505K1800D	5	90	99	2.5	15	690	3400	40	35	25	M6
STG-01A605K1800D	6	90	99	2.4	15	480	2800	45	40	30	M6
STG-01A805K1800D-V2	8	90	134	2.4	22	480	3800	45	40	30	M6
STG-01A106K1800D-V2	10	90	134	2.2	22	480	4800	55	50	40	M6
STG-01A126K1800D-V2	12	90	134	2.1	22	310	3700	55	50	40	M6

**STG-A V<sub>ndc</sub> = 1800V / V<sub>rms</sub> = 600Vac / V<sub>peak</sub> = 850V 10s / V<sub>surge</sub> = 2700V 30s/day**

P/N :	C <sub>n</sub> uF	Diameter D mm	Length L mm	ESR mohm 100khz	ESL nH	dv/dt v/us	Peak Current I <sub>peak</sub> A	Max. Amp 45C	Max. Amp 55C	Max. Amp 85C	d (mm)
STG-A405J1800D	4	65	92	5.0	55	300	1200	25	18	12	M6
STG-A475J1800D	4.7	65	92	5.0	55	300	1400	30	20	15	M6
STG-A605J1800D	6	65	92	4.5	55	300	1800	35	25	17	M6
STG-A805J1800D	8	65	92	4.5	55	200	1600	40	30	20	M6
STG-A106J1800D	10	90	92	4.0	55	300	3000	55	40	30	M6
STG-A126J1800D	12	90	92	4.0	55	260	3100	65	50	35	M6

For other Capacitance, Voltage, dv/dt, Peak Current and RMS Current not listed, please contact us for a suggestion.

**STG-01A V<sub>ndc</sub> = 2000V / V<sub>rms</sub> = 650Vac / V<sub>peak</sub> = 920V 10s / V<sub>surge</sub> = 3000V 30s/day**

P/N :	C <sub>n</sub> uF	Diameter D mm	Length L mm	ESR mohm 100khz	ESL nH	dv/dt v/us	Peak Current I <sub>peak</sub> A	Max. Amp 45C	Max. Amp 55C	Max. Amp 70C	Max. Amp 85C	d (mm)
STG-01A504J2000D	0.5	65	50	1.6	11	1880	940	22	18	12	7	M6
STG-01A684J2000D	0.68	65	50	1.5	11	1880	1200	30	25	17	10	M6
STG-01A105J2000D	1	65	50	1.2	11	1880	1900	45	35	25	15	M6
STG-01A125J2000D	1.2	65	62	1.6	15	1040	1200	30	25	16	10	M6
STG-01A155J2000D	1.5	65	62	1.5	15	1040	1500	35	30	30	20	M6

**STG-01A V<sub>ndc</sub> = 2100V / V<sub>rms</sub> = 700Vac / V<sub>peak</sub> = 700V 10s / V<sub>surge</sub> = 3150V 10s/day**

P/N :	C <sub>n</sub> uF	Diameter D mm	Length L mm	ESR mohm 100khz	ESL nH	dv/dt v/us	Peak Current I <sub>peak</sub> A	Max. Amp 70C	Max. Amp 85C	Max. Amp 105C	d (mm)
STG-01A405K2100D	4	90	153	2.4	17	1120	4500	50	40	30	M6
STG-01A505K2100D	5	90	153	2.2	17	1120	5600	65	55	45	M6
STG-01A605K2100D	6	90	190	2.1	20	780	4600	65	55	45	M6
STG-01A805K2100D	8	90	260	2.5	33	500	4000	45	35	25	M6
STG-01A106K2100D	10	90	260	2.3	33	500	5000	60	50	40	M6
STG-01A126K2100D	12	90	260	1.9	33	500	6000	70	60	50	M6

**STG-A V<sub>ndc</sub> = 2500V / V<sub>rms</sub> = 900Vac / V<sub>peak</sub> = 1270V 10s / V<sub>surge</sub> = 3800V 30s/day**

P/N :	C <sub>n</sub> uF	Diameter D mm	Length L mm	ESR mohm 100khz	ESL nH	dv/dt v/us	Peak Current I <sub>peak</sub> A	Max. Amp 45C	Max. Amp 55C	Max. Amp 85C	d (mm)
STG-A225J2500D	2.2	65	92	5.0	55	530	1100	25	20	15	M6
STG-A335J2500D	3.3	65	92	4.5	55	530	1700	35	25	20	M6
STG-A475J2500D	4.7	90	92	4.0	55	530	2500	50	40	30	M6
STG-A685J2500D	6.8	90	92	4.0	55	530	3600	70	55	40	M6

**STG-01A V<sub>ndc</sub> = 2500V / V<sub>rms</sub> = 950Vac / V<sub>peak</sub> = 1300V 10s / V<sub>surge</sub> = 3750V 10s/day**

P/N :	C <sub>n</sub> uF	Diameter D mm	Length L mm	ESR mohm 100khz	ESL nH	dv/dt v/us	Peak Current I <sub>peak</sub> A	Max. Amp 70C	Max. Amp 85C	Max. Amp 105C	d (mm)
STG-01A255K2500D	2.5	65	280	2.8	33	540	1300	40	35	25	M6
STG-01A305K2500D	3	65	280	2.6	33	540	1600	50	40	30	M6
STG-01A405K2500D	4	65	280	2.9	33	540	2100	50	40	30	M6
STG-01A505K2500D	5	65	280	2.6	33	540	2700	60	50	40	M6
STG-01A605K2500D	6	90	280	2.3	33	540	3200	70	60	50	M6
STG-01A805K2500D	8	90	280	2.1	33	540	4300	70	60	50	M6

**STG-A V<sub>ndc</sub> = 2600V / V<sub>rms</sub> = 1000Vac / V<sub>peak</sub> = 1450V 10s / V<sub>surge</sub> = 3900V 30s/day**

P/N :	C <sub>n</sub> uF	Diameter D mm	Length L mm	ESR mohm 100khz	ESL nH	dv/dt v/us	Peak Current I <sub>peak</sub> A	Max. Amp 55C	Max. Amp 70C	Max. Amp 85C	d (mm)
STG-A1755J2600D	1.75	65	89	2.5	11	1280	2200	30	25	21	M6
STG-A205J2600D	2	65	89	2.2	11	1280	2500	30	25	21	M6
STG-A225J2600D	2.2	65	89	2.2	11	1280	2800	36	30	25	M6

**STG-01A V<sub>ndc</sub> = 2700V / V<sub>rms</sub> = 770Vac / V<sub>peak</sub> = 1100V 10s / V<sub>surge</sub> = 4350V 30s/day**

P/N :	C <sub>n</sub> uF	Diameter D mm	Length L mm	ESR mohm 100khz	ESL nH	dv/dt v/us	Peak Current I <sub>peak</sub> A	Max. Amp 70C	Max. Amp 85C	Max. Amp 105C	d (mm)
STG-01A205K2700D	2	65	160	1.6	50	1000	2000	60	50	25	M6
STG-01A255K2700D	2.5	65	190	1.6	60	800	2000	60	50	25	M6
STG-01A335K2700D	3.3	65	220	1.5	75	600	1980	60	50	25	M6
STG-01A405K2700D	4	65	220	1.3	75	600	2400	65	55	30	M6

**STG-01A V<sub>ndc</sub> = 3000V / V<sub>rms</sub> = 1000Vac / V<sub>peak</sub> = 1500V 10s / V<sub>surge</sub> = 4900V 10s/day**

P/N :	C <sub>n</sub> uF	Diameter D mm	Length L mm	ESR mohm 100khz	ESL nH	dv/dt v/us	Peak Current I <sub>peak</sub> A	Max. Amp 70C	Max. Amp 85C	Max. Amp 105C	d (mm)
STG-01A205K3000D	2	90	280	2.6	33	800	1600	40	30	22	M6
STG-01A255K3000D	2.5	90	280	2.7	33	800	2000	40	30	22	M6
STG-01A305K3000D	3	90	280	2.6	33	800	2400	50	40	25	M6
STG-01A405K3000D	4	90	280	2.3	33	800	3200	60	50	40	M6
STG-01A505K3000D	5	90	280	2.1	33	800	4000	70	60	45	M6

**STG-A V<sub>ndc</sub> = 3000V / V<sub>rms</sub> = 1100Vac / V<sub>peak</sub> = 1600V 10s / V<sub>surge</sub> = 4300V 30s/day**

P/N :	C <sub>n</sub> uF	Diameter D mm	Length L mm	ESR mohm 100khz	ESL nH	dv/dt v/us	Peak Current I <sub>peak</sub> A	Max. Amp 45C	Max. Amp 55C	Max. Amp 85C	d (mm)
STG-A225J3000D	2.2	65	92	4.0	55	1180	2600	35	30	25	M6
STG-A335J3000D	3.3	65	92	4.0	55	1180	3900	50	45	40	M6

For other Capacitance, Voltage, dv/dt, Peak Current and RMS Current not listed, please contact us for a suggestion.

**STG-01A V<sub>ndc</sub> = 3100V / V<sub>rms</sub> = 900Vac / V<sub>peak</sub> = 1300V 10s / V<sub>surge</sub> = 5000V 30s/day**

P/N :	C <sub>n</sub> uF	Diameter D mm	Length L mm	ESR mohm 100khz	ESL nH	dv/dt v/us	Peak Current I <sub>peak</sub> A	Max. Amp 70C	Max. Amp 85C	Max. Amp 105C	d (mm)
STG-01A155K3100D	1.5	65	160	1.6	50	1320	1980	50	40	20	M6
STG-01A205K3100D	2	65	190	1.5	60	1000	2000	50	40	20	M6
STG-01A225K3100D	2.2	65	190	1.3	60	1000	2200	50	40	20	M6
STG-01A255K3100D	2.5	65	190	1.2	60	1000	2500	60	50	25	M6
STG-01A305K3100D	3	65	220	1.3	75	800	2400	60	50	25	M6
STG-01A335K3100D	3.3	90	220	1.2	75	800	2640	65	55	27	M6
STG-01A355K3100D	3.5	90	220	1.1	75	800	2800	65	55	27	M6

**STG-01A V<sub>ndc</sub> = 3200V / V<sub>rms</sub> = 780Vac / V<sub>peak</sub> = 1100V 10s / V<sub>surge</sub> = 4800V 30s/day**

P/N :	C <sub>n</sub> uF	Diameter D mm	Length L mm	ESR mohm 100khz	ESL nH	dv/dt v/us	Peak Current I <sub>peak</sub> A	Max. Amp 55C	Max. Amp 70C	Max. Amp 85C	Max. Amp 105C	d (mm)
STG-01A254K3200D	0.25	65	93	4.5	32	1450	360	17	12.5	7.5	4.62	M6
STG-01A334K3200D	0.33	65	93	4.0	32	1450	480	17	12.5	8	4.5	M6
STG-01A504K3200D	0.5	65	93	4.0	32	1450	720	25	20	12	6.9	M6
STG-01A754K3200D	0.75	65	93	3.5	32	1450	1000	40	30	18	10.4	M6
STG-01A105K3200D	1	65	115	3.5	40	800	800	30	23	13.5	7.7	M6
STG-01A155K3200D	1.5	65	131	3.0	45	650	975	35	26	16	8.9	M6

**STG-01A V<sub>ndc</sub> = 3500V / V<sub>rms</sub> = 920Vac / V<sub>peak</sub> = 1300V 10s / V<sub>surge</sub> = 5300V 30s/day**

P/N :	C <sub>n</sub> uF	Diameter D mm	Length L mm	ESR mohm 100khz	ESL nH	dv/dt v/us	Peak Current I <sub>peak</sub> A	Max. Amp 55C	Max. Amp 70C	Max. Amp 85C	Max. Amp 105C	d (mm)
STG-01A254K3500D	0.25	65	93	5.0	32	1900	470	16	12.5	8	5	M6
STG-01A334K3500D	0.33	65	93	4.5	32	1900	620	25	20	12	8	M6
STG-01A504K3500D	0.5	65	93	4.0	32	1900	950	40	30	18	11	M6
STG-01A754K3500D	0.75	65	115	3.5	40	1100	820	30	23	13	8	M6
STG-01A105K3500D	1	65	133	3.5	45	825	820	35	26	16	10	M6

**STG-01A V<sub>ndc</sub> = 3600V / V<sub>rms</sub> = 1100Vac / V<sub>peak</sub> = 1600V 10s / V<sub>surge</sub> = 5760V 30s/day**

P/N :	C <sub>n</sub> uF	Diameter D mm	Length L mm	ESR mohm 100khz	ESL nH	dv/dt v/us	Peak Current I <sub>peak</sub> A	Max. Amp 70C	Max. Amp 85C	Max. Amp 105C	d (mm)
STG-01A155K3600D	1.5	65	200	1.6	70	1355	2000	60	50	25	M6
STG-01A205K3600D	2	65	235	1.7	85	1000	2000	60	50	25	M6
STG-01A255K3600D	2.5	65	280	1.6	100	800	2000	60	50	25	M6
STG-01A305K3600D	3	65	280	1.3	100	800	2400	70	60	30	M6

**STG-01A V<sub>ndc</sub> = 4000V / V<sub>rms</sub> = 1200Vac / V<sub>peak</sub> = 1700V 10s / V<sub>surge</sub> = 6000V 30s/day**

P/N :	C <sub>n</sub> uF	Diameter D mm	Length L mm	ESR mohm 100khz	ESL nH	dv/dt v/us	Peak Current I <sub>peak</sub> A	Max. Amp 70C	Max. Amp 85C	Max. Amp 105C	d (mm)
STG-01A155K4000D-V1	1.5	90	280	2.5	33	1280	1900	35	30	20	M6
STG-01A155K4000D-V2	1.5	65	280	2.5	33	1280	1900	30	25	18	M6
STG-01A205K4000D-V1	2	90	280	2.3	33	1280	2500	50	40	25	M6
STG-01A205K4000D-V2	2	65	280	2.3	33	1280	2500	40	30	20	M6
STG-01A255K4000D-V1	2.5	90	280	2.1	33	1280	3200	60	50	35	M6
STG-01A255K4000D-V2	2.5	90	280	2.1	33	1280	3200	50	40	30	M6
STG-01A305K4000D-V1	3	90	280	2.2	33	1280	3800	60	50	35	M6
STG-01A305K4000D-V2	3	90	280	2.0	33	1280	3800	60	50	35	M6

**STG-01A V<sub>ndc</sub> = 4500V / V<sub>rms</sub> = 1350Vac / V<sub>peak</sub> = 1950V 10s / V<sub>surge</sub> = 7200V 30s/day**

P/N :	C <sub>n</sub> uF	Diameter D mm	Length L mm	ESR mohm 100khz	ESL nH	dv/dt v/us	Peak Current I <sub>peak</sub> A	Max. Amp 70C	Max. Amp 85C	Max. Amp 105C	d (mm)
STG-01A254K4500D	0.25	65	130	2.1	35	5000	1200	30	25	15	M6
STG-01A504K4500D	0.5	65	160	1.8	50	2900	1400	30	25	15	M6
STG-01A754K4500D	0.75	65	160	1.3	50	2900	2100	50	40	23	M6
STG-01A105K4500D	1	65	190	1.2	60	2200	2200	50	40	23	M6
STG-01A125K4500D	1.2	65	220	1.3	75	1700	2000	50	40	23	M6
STG-01A155K4500D	1.5	90	220	1.1	75	1700	2500	55	45	27	M6

**STG-01A V<sub>ndc</sub> = 5000V / V<sub>rms</sub> = 1400Vac / V<sub>peak</sub> = 2000V 10s / V<sub>surge</sub> = 7500V 30s/day**

P/N :	C <sub>n</sub> uF	Diameter D mm	Length L mm	ESR mohm 100khz	ESL nH	dv/dt v/us	Peak Current I <sub>peak</sub> A	Max. Amp 70C	Max. Amp 85C	Max. Amp 105C	d (mm)
STG-01A155K5000D	1.5	90	280	2.4	33	1850	2700	35	30	20	M6
STG-01A205K5000D	2	90	280	2.2	33	1850	3700	45	40	25	M6
STG-01A255K5000D	2.5	90	280	1.9	33	1850	4600	60	50	35	M6

For other Capacitance, Voltage, dv/dt, Peak Current and RMS Current not listed, please contact us for a suggestion.

Headquarter & Production : HK Film Capacitor Ltd

Worldwide Sales Office : HKFC Industrial Pty Ltd

<https://www.hkfc-industrial.com> email : [enquiry@hkfc-industrial.com](mailto:enquiry@hkfc-industrial.com)

**STG-01A V<sub>ndc</sub> = 5300V / V<sub>rms</sub> = 1600Vac / V<sub>peak</sub> = 2300V 10s / V<sub>surge</sub> = 8500V 30s/day**

P/N :	C <sub>n</sub> uF	Diameter D mm	Length L mm	ESR mohm 100khz	ESL nH	dv/dt v/us	Peak Current I <sub>peak</sub> A	Max. Amp 70C	Max. Amp 85C	Max. Amp 105C	d (mm)
STG-01A254K5300D	0.25	65	130	1.6	35	7000	1700	40	30	15	M6
STG-01A504K5300D	0.5	65	160	1.3	50	3900	1900	40	30	20	M6
STG-01A754K5300D	0.75	65	220	1.6	75	2300	1700	40	30	20	M6
STG-01A105K5300D	1	90	220	1.2	75	2300	2300	45	35	25	M6

**STG-A V<sub>ndc</sub> = 5800V / V<sub>rms</sub> = 2000Vac / V<sub>peak</sub> = 2850V 10s / V<sub>surge</sub> = 8700V 30s/day**

P/N :	C <sub>n</sub> uF	Diameter D mm	Length L mm	ESR mohm 100khz	ESL nH	dv/dt v/us	Peak Current I <sub>peak</sub> A	Max. Amp 55C	Max. Amp 70C	Max. Amp 85C	d (mm)
STG-A334J5800D	0.33	65	99	3.30	8.5	4860	1600	30	25	21	M6

For other Capacitance, Voltage, dv/dt, Peak Current and RMS Current not listed, please contact us for a suggestion.



### 3.2 Snubber Capacitors : STP-01R series

This series of capacitors have been specially developed for medium frequency range, higher dv/dt, peak current carrying capability.

#### Applications :

SCR Snubber and Commutation, Thyristor controlled rectifier circuits, Reduce or eliminate voltage or current spikes, Limit dv/dt and di/dt, Motor Speed Control and Static Drive, Harmonic Filter, Inverter and Converter.

#### Properties :

Low ESR, Excellent Frequency Response, High RMS Current Rating, High Pulse Current Ratings dv/dt, High Temperature, High Insulation Resistance, Low inductive, Flame Retardant Construction, Easy Installation

#### Electrical Connections :

STP-01R –Quick Terminals / Soldering tags or M6 Screw Threads

#### Electrical Characteristics :

**Rated Voltage** : 1,000 – 1,320Vndc / 660Vrms – 1,100Vrms ( can be customized )

**Capacitance range** : 0.1 - 1.5uF ( can be customized )

**Capacitance Tolerance** : +/-5%; +/-10%

**Ripple RMS Current** : up to 16A

**Equivalent Series Resistance (ESR)** : measured at 25C 100kHz

**Testing Voltage Terminal to Terminal** : Vsurge 10 sec ( can be customized )

**Testing Voltage Terminal to Case** : 4,500Vac at 105C 1min.

**Insulation Resistance** :250Vdc +25C >= 300,000Mohm

250Vdc +85C >= 50,000Mohm

250Vdc +105C >= 5,000Mohm

**Reference Standard** : IEC61071

**Operate Temperature** : +70C / +85C / +105C

**Expected Service Life** : 30,000 hours at rated Vac +85C / +105C

100,000 hours at rated Vdc +85C / +105C

**Accelerated Life** : 1.25 x rated AC voltage at +85C / +105C for 2,000 hours

Ultra-Low Leakage version is available on request

#### Specifications and Size :

**STP-01R Vndc = 1000V / Vrms = 660Vac / Vpeak = 940V 10s / Vsurge = 1700V 30s/day**

P/N :	Cn uF	Diameter D mm	Length L Mm	ESR mohm 100khz	ESL nH	dv/dt v/us	Peak Current I <sub>peak</sub> A	Max. Amp 85C	Max. Amp 105C
STP-01R474J1000D	0.47	30	55	7	40	620	290	7.5	3.3
STP-01R684J1000D	0.68	35	55	7	40	620	420	7.5	3.3
STP-01R105J1000D	1	35	73	7	50	480	480	14	6.0
STP-01R125J1000D	1.2	35	73	6	50	480	570	14	6.0
STP-01R155J1000D	1.5	40	73	6	50	480	720	14	6.0

**STP-01R Vndc = 1200V / Vrms = 800Vac / Vpeak = 1130V 10s / Vsurge = 2000V 30s/day**

P/N :	Cn uF	Diameter D mm	Length L Mm	ESR mohm 100khz	ESL nH	dv/dt v/us	Peak Current I <sub>peak</sub> A	Max. Amp 85C	Max. Amp 105C
STP-01R224J1200D	0.22	30	55	7	30	1300	280	7.5	3.3
STP-01R334J1200D	0.33	35	55	7	30	1300	430	7.5	3.3
STP-01R474J1200D	0.47	35	55	6	40	740	340	9	4.0
STP-01R684J1200D	0.68	35	73	6	50	570	380	9	4.0
STP-01R105J1200D	1	40	73	5	50	570	570	9	4.0

**STP-01R Vndc = 1350V / Vrms = 900Vac / Vpeak = 1270V 10s / Vsurge = 2300V 30s/day**

P/N :	Cn uF	Diameter D mm	Length L Mm	ESR mohm 100khz	ESL nH	dv/dt v/us	Peak Current I <sub>peak</sub> A	Max. Amp 85C	Max. Amp 105C
STP-01R104J1350D	0.1	30	55	7	30	1500	150	4	1.7
STP-01R154J1350D	0.15	30	55	7	30	1500	220	6	2.6
STP-01R224J1350D	0.22	30	55	8	40	850	180	5	2.1
STP-01R334J1350D	0.33	35	55	8	40	850	280	7	3.2
STP-01R474J1350D	0.47	35	73	6	50	660	310	8	3.5
STP-01R684J1350D	0.68	40	73	6	50	660	440	11	5.0
STP-01R105J1350D	1	45	73	5	50	660	660	16	7.0

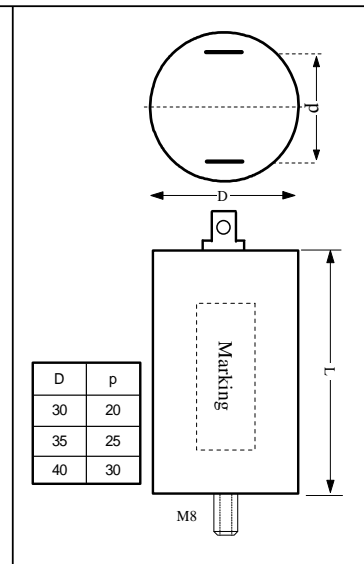

### 3.3 High Voltage Snubber Capacitors :

#### STP-01RNM, STP-01RBM series

This series of capacitors have been specially developed for medium frequency range, with higher RMS Current, higher dv/dt and higher peak current carrying capability.

#### Applications :

High Voltage SCR Snubber and Commutation, Thyristor controlled rectifier circuits, High Current Snubber circuit, Reduce or eliminate voltage or current spikes, Limit dv/dt & di/dt, Motor Speed Control & Static Drive, Harmonic Filter, Inverter, Converter and high RMS ripple Current application

#### Properties :

Low ESR, Excellent Frequency Response, High r.m.s. Current Rating, High Pulse Current Ratings (dv/dt), High Voltage Capabilities, High Temperature, High Insulation Resistance, Non inductive, Flame Retardant Construction, Easy Installation

#### Electrical Connections :

**STP-01RBM** – with M6 / M8 / M10 Screw Threads

**STP-01RNM** – with M6 / M8 / M10 Screw Nuts

**Electrical Characteristics :** ( can be customized )

**Rated Voltage :** 900Vndc – 5,300Vndc / 280Vrms – 1,600Vrms

**Capacitance range :** 0.25 - 60uF

**Capacitance Tolerance :** +/-5%; +/-10%

**Ripple RMS Current :** up to 80A

**Equivalent Series Resistance (ESR) :** at 23C 100kHz

**Testing Voltage Terminal to Terminal :** Vsurge 10 sec

**Testing Voltage Terminal to Case :** 4500Vac at 105C 1min.

**Insulation Resistance :250Vdc +25C** >= 300,000Mohm

250Vdc +85C >= 50,000Mohm

250Vdc +105C >= 5,000Mohm

**Reference Standard :** IEC61071

**Operate Temperature :** +70C / +85C / +105C

**Expected Service Life :** 30,000 hours at rated Vac +70C /+85C / +105C

60,000 hours at rated Vdc +70C / +85C / +105C

**Accelerated Life :** 1.25 x rated AC voltage at +85C / +105C 2,000 hours

Ultra-Low Leakage version is available on request

#### Specifications and Size :

**STP-01RNM Vndc = 900V / Vrms = 280Vac / Vpeak = 400V 10s / Vsurge = 1440V 10s/day**

P/N :	Cn uF	Diameter D mm	Length L mm	ESR mohm 100khz	ESL nH	dv/dt v/us	Peak Current I <sub>peak</sub> A	Max. Amp 70C	Max. Amp 85C	Max. Amp 105C	d (mm)
STP-01RNM225J900D	2.2	65	91	2.2	20	720	1500	35	11	7	M6
STP-01RNM335J900D	3.3	65	87	2.4	20	400	1300	30	9	6	M6
STP-01RNM475J900D	4.7	65	92	2.3	20	400	1800	35	11	7	M6
STP-01RNM685J900D	6.8	90	94	2.0	20	300	2000	40	12	8	M6
STP-01RNM106J900D	10	90	104	1.9	20	300	3000	45	14	9	M6
STP-01RNM156J900D	15	90	102	1.7	20	250	3700	50	15	10	M8
STP-01RNM226J900D	22	90	150	2.0	35	250	5500	60	24	15	M8
STP-01RNM336J900D	33	90	205	2.0	23	250	8200	80	32	20	M8
STP-01RNM406J900D	40	90	220	1.7	23	250	10000	80	32	20	M8
STP-01RNM506J900D	50	90	278	1.9	18	250	12500	80	32	20	M8
STP-01RNM606J900D	60	90	278	1.7	18	250	15000	80	32	20	M8

**STP-01RNM Vndc = 1000V / Vrms = 300Vac / Vpeak = 450V 10s / Vsurge = 1600V 10s/day**

P/N :	Cn uF	Diameter D mm	Length L mm	ESR mohm 100khz	ESL nH	dv/dt v/us	Peak Current I <sub>peak</sub> A	Max. Amp 70C	Max. Amp 85C	Max. Amp 105C	d (mm)
STP-01RNM225J1000D	2.2	65	91	2.2	20	880	1900	35	11	7	M6
STP-01RNM335J1000D	3.3	65	87	2.4	20	490	1600	30	9	6	M6
STP-01RNM475J1000D	4.7	65	96	2.0	20	490	2300	40	12	8	M6
STP-01RNM685J1000D	6.8	90	98	2.0	20	400	2720	40	12	8	M6
STP-01RNM755J1000D	7.5	90	100	1.7	20	400	3000	45	14	9	M6
STP-01RNM106J1000D	10	90	100	1.7	20	300	3000	45	14	9	M6
STP-01RNM126J1000D	12	90	144	1.9	29	300	3600	50	20	13	M8
STP-01RNM156J1000D	15	90	146	1.9	29	300	4500	60	24	15	M8
STP-01RNM226J1000D	22	90	162	1.7	35	300	6600	70	28	18	M8
STP-01RNM256J1000D	25	90	196	1.9	23	300	7500	80	32	20	M8
STP-01RNM306J1000D	30	90	211	1.7	23	300	9000	80	32	20	M8
STP-01RNM336J1000D	33	90	220	1.7	23	300	9900	80	32	20	M8
STP-01RNM356J1000D	35	90	254	1.9	18	300	10500	80	32	20	M8
STP-01RNM406J1000D	40	90	266	1.7	18	300	12000	80	32	20	M8

For other Capacitance, Voltage, dv/dt, Peak Current and RMS Current not listed, please contact us for a suggestion.

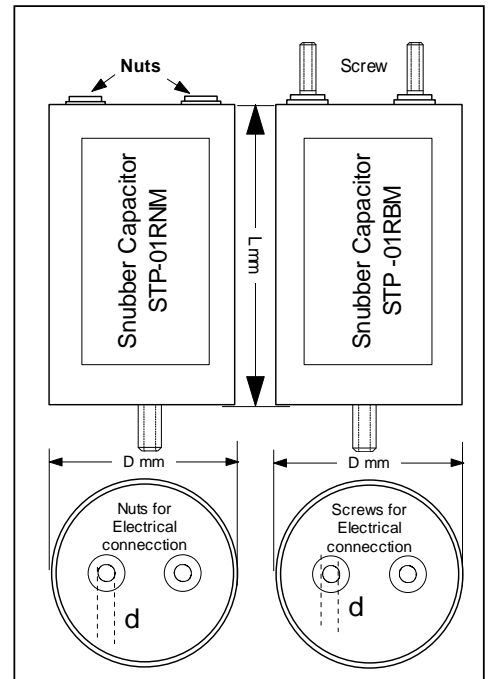

**STP-01RNM V<sub>ndc</sub> = 1300V / V<sub>rms</sub> = 400Vac / V<sub>peak</sub> = 580V 10s / V<sub>surge</sub> = 2100V 10s/day**

P/N :	C <sub>n</sub> uF	Diameter D mm	Length L mm	ESR mohm 100khz	ESL nH	dv/dt v/us	Peak Current I <sub>peak</sub> A	Max. Amp 70C	Max. Amp 85C	Max. Amp 105C	d (mm)
STP-01RNM225J1300D	2.2	65	88	2.3	20	680	1500	30	9	6	M6
STP-01RNM335J1300D	3.3	90	102	1.7	20	520	1700	40	12	8	M6
STP-01RNM475J1300D	4.7	90	101	1.8	20	520	2400	45	14	9	M6
STP-01RNM685J1300D	6.8	90	140	2.2	25	520	3500	50	20	13	M8
STP-01RNM755J1300D	7.5	90	146	1.9	29	520	3900	50	20	13	M8
STP-01RNM106J1300D	10	90	146	1.9	35	400	4000	55	22	14	M8
STP-01RNM126J1300D	12	90	156	1.7	35	400	4800	60	24	15	M8
STP-01RNM156J1300D	15	90	196	1.9	23	400	6000	70	28	18	M8
STP-01RNM206J1300D	20	90	246	1.9	18	400	8000	80	32	20	M8
STP-01RNM226J1300D	22	90	258	1.7	18	400	8800	80	32	20	M8
STP-01RNM256J1300D	25	90	274	1.7	18	400	10000	80	32	20	M8

**STP-01RNM V<sub>ndc</sub> = 1500V / V<sub>rms</sub> = 450Vac / V<sub>peak</sub> = 640V 10s / V<sub>surge</sub> = 2400V 10s/day**

P/N :	C <sub>n</sub> uF	Diameter D mm	Length L mm	ESR mohm 100khz	ESL nH	dv/dt v/us	Peak Current I <sub>peak</sub> A	Max. Amp 70C	Max. Amp 85C	Max. Amp 105C	d (mm)
STP-01RNM225J1500D	2.2	90	100	1.9	20	660	1400	35	11	7	M6
STP-01RNM335J1500D	3.3	90	102	1.7	20	660	2100	40	12	8	M6
STP-01RNM405J1500D	4	90	101	1.7	20	500	2000	40	12	8	M6
STP-01RNM455J1500D	4.5	90	104	1.7	20	500	2250	45	14	9	M6
STP-01RNM685J1500D	6.8	90	160	1.7	29	500	3400	55	22	14	M8
STP-01RNM755J1500D	7.5	90	154	1.8	35	500	3700	55	22	14	M8
STP-01RNM106J1500D	10	90	214	1.8	19	500	5000	70	28	18	M8
STP-01RNM126J1500D	12	90	211	1.7	23	500	6000	70	28	18	M8
STP-01RNM156J1500D	15	90	262	1.8	18	500	7500	80	32	20	M8
STP-01RNM186J1500D	18	90	278	1.7	18	500	9000	80	32	20	M8

**STP-01RNM V<sub>ndc</sub> = 1700V / V<sub>rms</sub> = 530Vac / V<sub>peak</sub> = 750V 10s / V<sub>surge</sub> = 2720V 30s/day**

P/N :	C <sub>n</sub> uF	Diameter D mm	Length L mm	ESR mohm 100khz	ESL nH	dv/dt v/us	Peak Current I <sub>peak</sub> A	Max. Amp 70C	Max. Amp 85C	Max. Amp 105C	d (mm)
STP-01RNM225K1700D	2.2	65	105	1.8	25	1200	2600	50	37	25	M6
STP-01RNM255K1700D	2.5	65	125	2.0	35	680	1700	45	33	22	M6
STP-01RNM305K1700D	3	65	125	2.3	35	680	2000	45	33	22	M6
STP-01RNM405K1700D	4	65	145	2.2	40	520	2100	45	33	22	M6
STP-01RNM505K1700D	5	65	165	2.3	50	400	2000	45	33	22	M6
STP-01RNM605K1700D	6	65	165	1.9	50	400	2400	55	40	26	M8

**STP-01RNM V<sub>ndc</sub> = 1800V / V<sub>rms</sub> = 540Vac / V<sub>peak</sub> = 760V 10s / V<sub>surge</sub> = 2900V 10s/day**

P/N :	C <sub>n</sub> uF	Diameter D mm	Length L mm	ESR mohm 100khz	ESL nH	dv/dt v/us	Peak Current I <sub>peak</sub> A	Max. Amp 70C	Max. Amp 85C	Max. Amp 105C	d (mm)
STP-01RNM225J1800D	2.2	90	100	1.9	20	800	1700	35	30	15	M6
STP-01RNM335J1800D	3.3	90	140	2.5	29	800	2600	45	30	17	M6
STP-01RNM475J1800D	4.7	90	146	2.0	35	620	2900	45	30	17	M6
STP-01RNM685J1800D	6.8	90	196	2.0	23	620	4200	55	35	20	M8
STP-01RNM805J1800D	8	90	205	1.8	23	620	4900	55	40	25	M8
STP-01RNM106J1800D	10	90	250	1.8	18	620	6200	60	45	30	M8
STP-01RNM126J1800D	12	90	270	1.7	18	620	7400	70	60	35	M8

**STP-01RNM V<sub>ndc</sub> = 2700V / V<sub>rms</sub> = 770Vac / V<sub>peak</sub> = 1100V 10s / V<sub>surge</sub> = 4350V 30s/day**

P/N :	C <sub>n</sub> uF	Diameter D mm	Length L mm	ESR mohm 100khz	ESL nH	dv/dt v/us	Peak Current I <sub>peak</sub> A	Max. Amp 70C	Max. Amp 85C	Max. Amp 105C	d (mm)
STP-01RNM205K2700D	2	65	165	2.4	50	1000	2000	35	26	17	M6
STP-01RNM255K2700D	2.5	65	185	2.4	60	800	2000	35	26	17	M6
STP-01RNM335K2700D	3.3	65	225	2.3	75	600	1980	35	26	17	M6
STP-01RNM405K2700D	4	65	225	1.9	75	600	2400	40	30	20	M6

**STP-01RNM V<sub>ndc</sub> = 3100V / V<sub>rms</sub> = 900Vac / V<sub>peak</sub> = 1300V 10s / V<sub>surge</sub> = 5000V 30s/day**

P/N :	C <sub>n</sub> uF	Diameter D mm	Length L mm	ESR mohm 100khz	ESL nH	dv/dt v/us	Peak Current I <sub>peak</sub> A	Max. Amp 70C	Max. Amp 85C	Max. Amp 105C	d (mm)
STP-01RNM155K3100D	1.5	65	165	2.4	50	1320	1900	30	22	15	M6
STP-01RNM205K3100D	2	65	185	2.2	60	1000	2000	30	22	15	M6
STP-01RNM225K3100D	2.2	65	185	2.0	60	1000	2200	30	22	15	M6
STP-01RNM255K3100D	2.5	65	185	1.8	60	1000	2500	35	26	17	M6
STP-01RNM305K3100D	3	65	225	1.9	75	800	2400	35	26	17	M6
STP-01RNM335K3100D	3.3	90	225	1.8	75	800	2600	35	26	17	M6
STP-01RNM355K3100D	3.5	90	225	1.7	75	800	2800	40	30	20	M6

For other Capacitance, Voltage, dv/dt, Peak Current and RMS Current not listed, please contact us for a suggestion.

**STP-01RNM V<sub>ndc</sub> = 3600V / V<sub>rms</sub> = 1100Vac / V<sub>peak</sub> = 1600V 10s / V<sub>surge</sub> = 5760V 30s/day**

P/N :	C <sub>n</sub> uF	Diameter D mm	Length L mm	ESR mohm 100khz	ESL nH	dv/dt v/us	Peak Current I <sub>peak</sub> A	Max. Amp 70C	Max. Amp 85C	Max. Amp 105C	d (mm)
STP-01RNM155K3600D	1.5	65	205	2.4	70	1355	2000	35	24	16	M6
STP-01RNM205K3600D	2	65	245	2.5	85	1000	2000	35	25	17	M6
STP-01RNM255K3600D	2.5	65	285	2.4	100	800	2000	35	24	16	M6
STP-01RNM305K3600D	3	65	285	1.9	100	800	2400	40	30	20	M6

**STP-01RNM V<sub>ndc</sub> = 4500V / V<sub>rms</sub> = 1350Vac / V<sub>peak</sub> = 1950V 10s / V<sub>surge</sub> = 7200V 30s/day**

P/N :	C <sub>n</sub> uF	Diameter D mm	Length L mm	ESR mohm 100khz	ESL nH	dv/dt v/us	Peak Current I <sub>peak</sub> A	Max. Amp 70C	Max. Amp 85C	Max. Amp 105C	d (mm)
STP-01RNM254K4500D	0.25	65	135	3.2	35	5000	1200	15	12	8	M6
STP-01RNM504K4500D	0.5	65	165	2.7	50	2900	1400	15	13	8	M6
STP-01RNM754K4500D	0.75	65	165	1.9	50	2900	2100	25	19	12	M6
STP-01RNM105K4500D	1	65	185	1.8	60	2200	2200	25	20	13	M6
STP-01RNM125K4500D	1.2	65	225	1.9	75	1700	2000	25	19	12	M6
STP-01RNM155K4500D	1.5	90	225	1.6	75	1700	2500	30	23	15	M6

**STP-01RNM V<sub>ndc</sub> = 5300V / V<sub>rms</sub> = 1600Vac / V<sub>peak</sub> = 2300V 10s / V<sub>surge</sub> = 8500V 30s/day**

P/N :	C <sub>n</sub> uF	Diameter D mm	Length L mm	ESR mohm 100khz	ESL nH	dv/dt v/us	Peak Current I <sub>peak</sub> A	Max. Amp 70C	Max. Amp 85C	Max. Amp 105C	d (mm)
STP-01RNM254K5300D	0.25	65	135	2.4	35	7000	1700	19	14	9	M6
STP-01RNM504K5300D	0.5	65	165	2.0	50	3900	1900	21	16	10	M6
STP-01RNM754K5300D	0.75	65	225	2.4	75	2300	1700	19	14	9	M6
STP-01RNM105K5300D	1	90	225	1.8	75	2300	2300	25	19	12	M6

For other Capacitance, Voltage, dv/dt, Peak Current and RMS Current not listed, please contact us for a suggestion.

### 3.4 High Voltage Snubber Capacitors :

#### STP-01RFT, STP-01RAN, STP-01RFN, STP-01RFB series

This series of capacitors have been specially developed for medium frequency range, with higher RMS Current, higher dv/dt and higher peak current carrying capability.

#### Applications :

High Voltage SCR Snubber and Commutation, Thyristor controlled rectifier circuits, High Current Snubber circuit, Reduce or eliminate voltage or current spikes, Limit dv/dt & di/dt, Motor Speed Control & Static Drive, Harmonic Filter, Inverter, Converter, AC Filter and high RMS ripple Current application

#### Properties :

Low ESR, Excellent Frequency Response, High r.m.s. Current Rating, High Pulse Current Ratings (dv/dt), High Voltage Capabilities, High Temperature, High Insulation Resistance, Non inductive, Flame Retardant Construction, Easy Installation

#### Electrical Characteristics : ( can be customized )

**STP-01RFT** – with a Screw Bolt and a Tab-Terminal

**STP-01RAN** – with Screw Nut x 2

**STP-01RFN** – with M6 Screw Nut + Screw Bolt

**STP-01RFB** – with M6 Screw Bolt x 2

**STP-01RBC** – with M6 Screw Bolt + a lead wire

**STP-01RNC** – with M6 Screw Nut + a lead wire

**Capacitance range** : 0.075uF – 10uF

**Rated Voltage range** : 350 – 4200Vrms / 1300 – 18KVndc

**Peak Current** : up to 5250App

**Ripple RMS Current** : up to 60A

**Equivalent Series Resistance (ESR)** : at 23C 100kHz

**Testing Voltage** Terminal to Terminal : Vsurge 10 sec

**Testing Voltage** Terminal to Case: 5,000Vac 105C 1min.

**Insulation Resistance** :250Vdc +25C >= 300,000Mohm

250Vdc +85C >= 50,000Mohm

250Vdc +105C >= 5,000Mohm

**Reference Standard** : IEC61071

**Operate Temperature** : +70C / +85C / +105C

Ultra-Low Leakage version is available on request

#### Specifications and Size :

**STP-01Rxx** : Vndc = 1300V / Vrms = 350Vac / Vpeak = 500V 10s / Vsurge = 2080V 15s/day

P/N :	Cn uF	Diameter D mm	Length L mm	dv/dt v/us	Peak Current I <sub>p-p</sub> A	ESL nH	ESR (mohm) 100KHz	Max. Amp 70C	Max. Amp 85C	Max. Amp 105C
STP-01Rxx305K1300D	3	65	130	500	1500	20	3.1	40	28	20
STP-01Rxx405K1300D	4	65	155	500	2000	22	2.8	40	28	20
STP-01Rxx505K1300D	5	90	130	500	2500	20	2.6	50	35	25
STP-01Rxx605K1300D	6	90	130	500	3000	20	2.4	55	38	28
STP-01Rxx805K1300D	8	90	155	400	3200	22	2.1	55	38	28
STP-01Rxx106K1300D	10	90	155	400	4000	22	1.8	60	40	30

**STP-01Rxx** : Vndc = 1600V / Vrms = 430Vac / Vpeak = 620V 10s / Vsurge = 2560V 15s/day

P/N :	Cn uF	Diameter D mm	Length L mm	dv/dt v/us	Peak Current I <sub>p-p</sub> A	ESL nH	ESR (mohm) 100KHz	Max. Amp 70C	Max. Amp 85C	Max. Amp 105C
STP-01Rxx504K1600D	0.5	65	130	1400	700	20	3.3	20	15	12
STP-01Rxx105K1600D	1	65	130	1400	1400	20	3.1	25	18	15
STP-01Rxx155K1600D	1.5	65	130	1400	2100	20	1.9	30	20	18
STP-01Rxx205K1600D	2	65	155	1000	2000	22	1.8	30	20	18
STP-01Rxx225K1600D	2.2	65	155	1000	2200	22	1.8	30	20	18
STP-01Rxx255K1600D	2.5	90	130	1400	3500	20	1.7	40	30	22
STP-01Rxx305K1600D	3	90	155	1000	3000	22	1.6	40	30	22
STP-01Rxx405K1600D	4	90	155	1000	4000	22	1.3	50	35	25

**STP-01Rxx** : Vndc = 2500V / Vrms = 660Vac / Vpeak = 940V 10s / Vsurge = 4000V 15s/day

P/N :	Cn uF	Diameter D mm	Length L mm	dv/dt v/us	Peak Current I <sub>p-p</sub> A	ESL nH	ESR (mohm) 100KHz	Max. Amp 70C	Max. Amp 85C	Max. Amp 105C
STP-01Rxx504K2500D	0.5	65	130	2500	1250	20	2.9	20	15	12
STP-01Rxx105K2500D	1	65	130	2500	2500	20	2.7	25	18	15
STP-01Rxx155K2500D	1.5	90	130	2500	3750	20	2.4	35	25	18
STP-01Rxx205K2500D	2	90	130	2500	5000	20	2.1	50	35	25
STP-01Rxx225K2500D	2.2	90	155	1900	4180	22	1.9	50	35	25
STP-01Rxx255K2500D	2.5	90	130	1900	4750	22	1.4	60	40	30

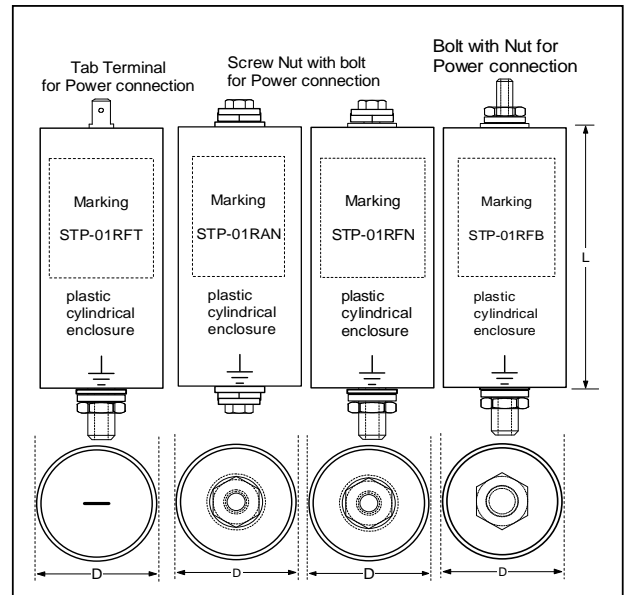

For other Capacitance, Voltage, dv/dt, Peak Current and RMS Current not listed, please contact us for a suggestion.

Headquarter & Production : HK Film Capacitor Ltd

Worldwide Sales Office : HKFC Industrial Pty Ltd

https://www.hkfc-industrial.com email : enquiry@hkfc-industrial.com

**STP-01Rxx : Vndc = 3300V / Vrms = 880Vac / Vpeak = 1250V 10s / Vsurge = 5200V 15s/day**

P/N :	Cn uF	Diameter D mm	Length L mm	dv/dt v/us	Peak Current I <sub>p-p</sub> A	ESL nH	ESR (mohm) 100KHz	Max. Amp 70C	Max. Amp 85C	Max. Amp 105C
STP-01Rxx334K3300D	0.33	65	190	3300	1089	20	3.1	20	15	12
STP-01Rxx504K3300D	0.5	65	190	3300	1650	20	2.9	20	15	12
STP-01Rxx105K3300D	1	90	190	3300	3300	20	2.7	35	25	18
STP-01Rxx125K3300D	1.2	90	190	3300	3960	20	2.4	40	28	20
STP-01Rxx155K3300D	1.5	90	240	2500	3750	22	2.1	40	28	20
STP-01Rxx205K3300D	2	90	240	2500	5000	22	1.9	55	38	28

**STP-01Rxx : Vndc = 3900V / Vrms = 1030Vac / Vpeak = 1470V 10s / Vsurge = 6200V 15s/day**

P/N :	Cn uF	Diameter D mm	Length L mm	dv/dt v/us	Peak Current I <sub>p-p</sub> A	ESL nH	ESR (mohm) 100KHz	Max. Amp 70C	Max. Amp 85C
STP-01Rxx254K3900D	0.25	65	102	1600	400	60	6.0	15	12
STP-01Rxx334K3900D	0.33	65	102	1600	528	60	5.4	15	12
STP-01Rxx504K3900D	0.5	65	102	1600	800	70	5	18	15
STP-01Rxx684K3900D	0.68	65	102	1600	1088	70	4.6	25	20
STP-01Rxx754K3900D	0.75	65	102	1600	1200	70	4.2	25	20
STP-01Rxx824K3900D	0.82	65	102	1600	1312	70	3.7	25	20
STP-01Rxx105K3900D	1	90	139	1600	1600	70	3.3	30	25
STP-01Rxx125K3900D	1.2	90	139	1600	1920	70	2.8	30	25
STP-01Rxx155K3900D	1.5	90	139	1600	2400	70	2.5	35	30

**STP-01Rxx : Vndc = 4600V / Vrms = 1200Vac / Vpeak = 1700V 10s / Vsurge = 7300V 15s/day**

P/N :	Cn uF	Diameter D mm	Length L mm	dv/dt v/us	Peak Current I <sub>p-p</sub> A	ESL nH	ESR (mohm) 100KHz	Max. Amp 70C	Max. Amp 85C	Max. Amp 105C
STP-01Rxx254K4600D	0.25	65	240	4600	1150	20	3.2	25	18	13
STP-01Rxx334K4600D	0.33	65	240	4600	1518	20	3.1	25	18	13
STP-01Rxx504K4600D	0.5	90	240	4600	2300	20	2.9	30	20	15
STP-01Rxx754K4600D	0.75	90	240	4600	3450	20	2.8	35	25	18
STP-01Rxx105K4600D	1	90	240	4600	4600	20	2.6	40	28	22
STP-01Rxx125K4600D	1.2	90	295	3500	4200	22	2.4	40	28	22
STP-01Rxx155K4600D	1.5	90	295	3500	5250	22	2.1	50	35	25

**STP-01Rxx : Vndc = 4700V / Vrms = 1200Vac / Vpeak = 1700V 10s / Vsurge = 7500V 15s/day**

P/N :	Cn uF	Diameter D mm	Length L mm	dv/dt v/us	Peak Current I <sub>p-p</sub> A	ESL nH	ESR (mohm) 100KHz	Max. Amp 70C	Max. Amp 85C
STP-01Rxx254K4700D	0.25	65	139	1900	475	70	6.3	15	10
STP-01Rxx334K4700D	0.33	65	139	1900	627	70	5.6	15	10
STP-01Rxx504K4700D	0.5	65	139	1900	950	70	5.1	25	20
STP-01Rxx684K4700D	0.68	90	139	1900	1292	70	4.6	25	20
STP-01Rxx754K4700D	0.75	90	139	1900	1425	70	4	30	25
STP-01Rxx824K4700D	0.82	90	139	1900	1558	70	3.7	30	25
STP-01Rxx105K4700D	1	90	139	1900	1900	70	3.4	35	30
STP-01Rxx125K4700D	1.2	90	139	1900	2280	70	3	35	30

**STP-01Rxx : Vndc = 5900V / Vrms = 1400Vac / Vpeak = 2100V 10s / Vsurge = 9400V 15s/day**

P/N :	Cn uF	Diameter D mm	Length L mm	dv/dt v/us	Peak Current I <sub>p-p</sub> A	ESL nH	ESR (mohm) 100KHz	Max. Amp 70C	Max. Amp 85C	Max. Amp 105C
STP-01Rxx224K5900D	0.22	65	295	5900	1298	20	3.3	20	15	10
STP-01Rxx254K5900D	0.25	65	295	5900	1475	20	3.2	25	18	13
STP-01Rxx334K5900D	0.33	65	295	5900	1947	20	3.1	25	18	13
STP-01Rxx504K5900D	0.5	90	295	5900	2950	20	2.9	30	20	16
STP-01Rxx684K5900D	0.68	90	295	5900	4012	20	2.6	35	25	18
STP-01Rxx754K5900D	0.75	90	295	5900	4425	20	2.1	40	28	20

**STP-01Rxx : Vndc = 6300V / Vrms = 1620Vac / Vpeak = 2300V 10s / Vsurge = 10080V 15s/day**

P/N :	Cn uF	Diameter D mm	Length L mm	dv/dt v/us	Peak Current I <sub>p-p</sub> A	ESL nH	ESR (mohm) 100KHz	Max. Amp 70C	Max. Amp 85C
STP-01Rxx224K6300D	0.22	65	139	2800	616	70	7	12	10
STP-01Rxx254K6300D	0.25	65	139	2800	700	70	6.0	12	10
STP-01Rxx334K6300D	0.33	65	139	2800	924	70	5.3	15	12
STP-01Rxx504K6300D	0.5	65	139	2800	1400	70	4.8	25	20
STP-01Rxx684K6300D	0.68	90	139	2800	1904	70	4.3	30	25
STP-01Rxx754K6300D	0.75	90	139	2800	2100	70	3.9	30	25
STP-01Rxx824K6300D	0.82	90	139	2800	2296	70	3.5	33	30

For other Capacitance, Voltage, dv/dt, Peak Current and RMS Current not listed, please contact us for a suggestion.

Headquarter & Production : HK Film Capacitor Ltd

Worldwide Sales Office : HKFC Industrial Pty Ltd

<https://www.hkfc-industrial.com> email : [enquiry@hkfc-industrial.com](mailto:enquiry@hkfc-industrial.com)



**STP-01Rxx : Vndc = 7000V / Vrms = 1550Vac / Vpeak = 2200V 10s / Vsurge = 11200V 15s/day**

P/N :	Cn uF	Diameter D mm	Length L mm	dv/dt v/us	Peak Current I <sub>p-p</sub> A	ESL nH	ESR (mohm) 100KHz	Max. Amp 70C	Max. Amp 85C
STP-01Rxx254K7000D	0.25	65	165	2600	650	35	5.3	20	15
STP-01Rxx334K7000D	0.33	65	272	2600	858	35	4.8	20	15
STP-01Rxx504K7000D	0.5	90	272	2600	1300	35	4.2	35	30
STP-01Rxx654K7000D	0.65	90	272	2600	1690	35	3.8	45	40
STP-01Rxx754K7000D	0.75	90	215	2600	1950	45	3.4	50	45
STP-01Rxx105K7000D	1	90	215	2600	2600	45	3	50	45

**STP-01Rxx : Vndc = 7900V / Vrms = 2000Vac / Vpeak = 2900V 10s / Vsurge = 12600V 15s/day**

P/N :	Cn uF	Diameter D mm	Length L mm	dv/dt v/us	Peak Current I <sub>p-p</sub> A	ESL nH	ESR (mohm) 100KHz	Max. Amp 70C	Max. Amp 85C	Max. Amp 105C
STP-01Rxx224K7900D	0.22	65	295	9000	1980	22	3.3	20	15	10
STP-01Rxx254K7900D	0.25	65	295	9000	2250	22	3.2	20	15	10
STP-01Rxx334K7900D	0.33	65	295	9000	2970	22	3.1	25	18	13
STP-01Rxx504K7900D	0.5	90	295	9000	4500	22	2.9	30	20	15

**STP-01Rxx : Vndc = 7900V / Vrms = 2050Vac / Vpeak = 2900V 10s / Vsurge = 12160V 15s/day**

P/N :	Cn uF	Diameter D mm	Length L mm	dv/dt v/us	Peak Current I <sub>p-p</sub> A	ESL nH	ESR (mohm) 100KHz	Max. Amp 70C	Max. Amp 85C
STP-01Rxx154K7900D	0.15	65	139	4400	660	70	9	8	7
STP-01Rxx224K7900D-V1	0.22	65	139	4400	968	70	7.6	10	8
STP-01Rxx254K7900D-V1	0.25	65	139	4400	1100	70	6.8	12	10
STP-01Rxx334K7900D-V1	0.33	90	139	4400	1452	70	6.1	15	12
STP-01Rxx504K7900D-V1	0.5	90	139	4400	2200	70	5.2	25	20

**STP-01Rxx : Vndc = 8000V / Vrms = 1700Vac / Vpeak = 2400V 10s / Vsurge = 11500V 15s/day**

P/N :	Cn uF	Diameter D mm	Length L mm	dv/dt v/us	Peak Current I <sub>p-p</sub> A	ESL nH	ESR (mohm) 100KHz	Max. Amp 70C	Max. Amp 85C
STP-01Rxx224K8000D	0.22	65	215	3500	770	45	5.5	22	18
STP-01Rxx254K8000D	0.25	65	215	3500	875	45	4.9	22	18
STP-01Rxx334K8000D	0.33	65	215	3500	1155	45	4.4	25	20
STP-01Rxx504K8000D	0.5	65	215	3500	1750	45	4.1	35	30
STP-01Rxx654K8000D	0.65	90	215	3500	2275	45	3.6	40	35
STP-01Rxx754K8000D	0.75	90	215	3500	2625	45	3.2	50	45
STP-01Rxx105K8000D	1	90	215	3500	3500	45	2.9	60	55

**STP-01Rxx : Vndc = 8000V / Vrms = 1900Vac / Vpeak = 2700V 10s / Vsurge = 12800V 15s/day**

P/N :	Cn uF	Diameter D mm	Length L mm	dv/dt v/us	Peak Current I <sub>p-p</sub> A	ESL nH	ESR (mohm) 100KHz	Max. Amp 70C	Max. Amp 85C
STP-01Rxx224K8000D	0.15	65	215	5000	750	45	6	15	13
STP-01Rxx204K8000D	0.2	65	215	5000	1000	45	5.4	18	15
STP-01Rxx224K8000D-V1	0.22	65	215	5000	1100	45	4.7	20	17
STP-01Rxx254K8000D-V1	0.25	65	215	5000	1250	45	4.2	25	20
STP-01Rxx334K8000D-V1	0.33	65	215	5000	1650	45	3.8	25	22
STP-01Rxx504K8000D-V1	0.5	90	215	5000	2500	45	3.4	40	35
STP-01Rxx654K8000D-V1	0.65	90	215	5000	3250	45	3.1	50	45
STP-01Rxx754K8000D-V1	0.75	90	215	5000	3750	45	2.8	50	45

**STP-01Rxx : Vndc = 9200V / Vrms = 2400Vac / Vpeak = 3400V 10s / Vsurge = 14700V 15s/day**

P/N :	Cn uF	Diameter D mm	Length L mm	dv/dt v/us	Peak Current I <sub>p-p</sub> A	ESL nH	ESR (mohm) 100KHz	Max. Amp 70C	Max. Amp 85C	Max. Amp 105C
STP-01Rxx104K9200D	0.1	65	295	13600	1360	15	4.5	20	15	10
STP-01Rxx124K9200D	0.12	65	295	13600	1632	15	3.8	20	15	10
STP-01Rxx154K9200D	0.15	90	295	13600	2040	15	3.2	25	20	15
STP-01Rxx204K9200D	0.2	90	295	13600	2720	15	2.9	30	25	20
STP-01Rxx224K9200D	0.22	90	295	13600	2992	15	2.6	35	30	25
STP-01Rxx254K9200D	0.25	90	295	13600	3400	15	2.4	35	30	25

**STP-01Rxx : Vndc = 9500V / Vrms = 2470Vac / Vpeak = 3500V 10s / Vsurge = 15200V 15s/day**

P/N :	Cn uF	Diameter D mm	Length L mm	dv/dt v/us	Peak Current I <sub>p-p</sub> A	ESL nH	ESR (mohm) 100KHz	Max. Amp 70C	Max. Amp 85C
STP-01Rxx104K9500D	0.1	65	196	4800	480	75	10	8	7
STP-01Rxx124K9500D	0.12	65	196	4800	576	75	9	8	7
STP-01Rxx154K9500D	0.15	65	196	4800	720	75	8.2	8	7
STP-01Rxx224K9500D	0.22	90	196	4800	1056	75	7.3	12	10
STP-01Rxx254K9500D	0.25	90	196	4800	1200	75	6.5	15	12
STP-01Rxx334K9500D	0.33	90	196	4800	1584	75	5.9	20	15

**STP-01Rxx : Vndc = 10000V / Vrms = 2400Vac / Vpeak = 3400V 10s / Vsurge = 16000V 15s/day**

P/N :	Cn uF	Diameter D mm	Length L mm	dv/dt v/us	Peak Current I <sub>p-p</sub> A	ESL nH	ESR (mohm) 100KHz	Max. Amp 70C	Max. Amp 85C
STP-01Rxx124K10kD	0.12	65	262	5800	696	60	6.2	15	13
STP-01Rxx154K10kD	0.15	65	262	5800	870	60	5.7	15	13
STP-01Rxx204K10kD	0.2	65	262	5800	1160	60	5	20	17
STP-01Rxx224K10kD	0.22	65	262	5800	1276	60	4.5	20	17
STP-01Rxx254K10kD	0.25	65	262	5800	1450	60	4	25	22
STP-01Rxx334K10kD	0.33	90	262	5800	1914	60	3.7	30	25
STP-01Rxx504K10kD	0.5	90	262	5800	2900	60	3.2	45	40
STP-01Rxx654K10kD	0.65	90	262	5800	3770	60	3.0	50	45

**STP-01Rxx : Vndc = 11900V / Vrms = 3100Vac / Vpeak = 4400V 10s / Vsurge = 19040V 15s/day**

P/N :	Cn uF	Diameter D mm	Length L mm	dv/dt v/us	Peak Current I <sub>p-p</sub> A	ESL nH	ESR (mohm) 100KHz	Max. Amp 70C	Max. Amp 85C
STP-01Rxx753K11900D	0.075	65	272	6100	458	90	12	7	6
STP-01Rxx104K11900D	0.1	65	272	6100	610	90	10.5	9	7
STP-01Rxx124K11900D	0.12	65	272	6100	732	90	9.6	10	8
STP-01Rxx154K11900D	0.15	90	272	6100	915	90	8.7	12	10
STP-01Rxx204K11900D	0.2	90	272	6100	1220	90	7.6	12	10
STP-01Rxx224K11900D	0.22	90	272	6100	1342	90	6.8	18	15
STP-01Rxx254K11900D	0.25	90	272	6100	1525	90	6.2	18	15

**STP-01Rxx : Vndc = 12000V / Vrms = 2900Vac / Vpeak = 4100V 10s / Vsurge = 19000V 15s/day**

P/N :	Cn uF	Diameter D mm	Length L mm	dv/dt v/us	Peak Current I <sub>p-p</sub> A	ESL nH	ESR (mohm) 100KHz	Max. Amp 70C	Max. Amp 85C
STP-01Rxx104K12kD	0.1	65	295	7300	730	70	6.5	15	13
STP-01Rxx124K12kD	0.12	65	295	7300	876	70	5.9	15	13
STP-01Rxx154K12kD	0.15	65	295	7300	1095	70	5.3	20	17
STP-01Rxx204K12kD	0.2	65	295	7300	1460	70	4.7	20	17
STP-01Rxx224K12kD	0.22	65	295	7300	1606	70	4.3	20	17
STP-01Rxx254K12kD	0.25	90	295	7300	1825	70	3.9	30	25
STP-01Rxx334K12kD	0.33	90	295	7300	2409	70	3.6	40	25
STP-01Rxx504K12kD	0.5	90	295	7300	3650	70	3.1	50	45

**STP-01Rxx : Vndc = 17000V / Vrms = 4400Vac / Vpeak = 6300V 10s / Vsurge = 27200V 15s/day**

P/N :	Cn uF	Diameter D mm	Length L mm	dv/dt v/us	Peak Current I <sub>p-p</sub> A	ESL nH	ESR (mohm) 100KHz	Max. Amp 70C	Max. Amp 85C
STP-01Rxx753K17kD	0.075	65	272	8200	615	90	13	8	7
STP-01Rxx104K17kD	0.1	65	272	8200	820	90	11.2	10	8
STP-01Rxx124K17kD	0.12	65	272	8200	984	90	10	12	10
STP-01Rxx154K17kD	0.15	90	272	8200	1230	90	9	15	12
STP-01Rxx204K17kD	0.2	90	272	8200	1640	90	7.7	15	12
STP-01Rxx224K17kD	0.22	90	272	8200	1804	90	6.9	20	15
STP-01Rxx254K17kD	0.25	90	272	8200	2050	90	6.1	25	20

**STP-01Rxx : Vndc = 18000V / Vrms = 4200Vac / Vpeak = 6000V 10s / Vsurge = 28800V 15s/day**

P/N :	Cn uF	Diameter D mm	Length L mm	dv/dt v/us	Peak Current I <sub>p-p</sub> A	ESL nH	ESR (mohm) 100KHz	Max. Amp 70C	Max. Amp 85C
STP-01Rxx104K18kD	0.1	65	295	10900	1090	80	6.2	20	17
STP-01Rxx124K18kD	0.12	65	295	10900	1308	80	5.6	20	17
STP-01Rxx154K18kD	0.15	90	295	10900	1635	80	5	25	20
STP-01Rxx204K18kD	0.2	90	295	10900	2180	80	4.5	30	25
STP-01Rxx224K18kD	0.22	90	295	10900	2398	80	4	35	30
STP-01Rxx254K18kD	0.25	90	295	10900	2725	80	3.4	40	35

For other Capacitance, Voltage, dv/dt, Peak Current and RMS Current not listed, please contact us for a suggestion.



### 3.5.1 Snubber Capacitors – IGBT SMKP2-L series

#### Applications :

For protection against voltage and current transients in IGBT modules and applications where high dv/dt is encountered

#### Construction :

- Low inductance construction
- Flame retardant plastic case and Epoxy Resin UL94-V0
- High Current carrying capacity Tinned Terminals for direct mounting the capacitor to IGBT module
- other Terminals also available

**Construction :** SMKP2-series

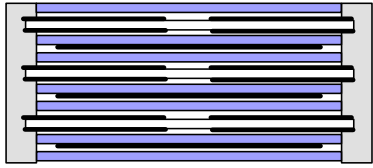

#### Electrical Characteristics :

Capacitance : 0.1uF - 3uF at 1kHz +25C

Capacitance Tolerance : +/-5%(J), +/-10% (K)

Rated Voltage Ur	1000Vdc	1200Vdc	1600Vdc	2000Vdc
	500Vac	550Vac	630Vac	650Vac

**Test Voltage :** between Terminals :1.6xUr Vdc 60s +85C / +105C  
Terminals to Case: 3kVac 60s at +25C / +105C

**Ripple RMS Current :** up to 32A

**Rated Temperature :** +85C / +105C

**Service Life :** 30,000 hours at rated Vac 70C  
60,000 hours at rated Vdc 70C

**Accelerated Life :** 1.25 x rated Vac at 85C for 3,000 hours  
1.25 x rated Vac at 105C for 2,000 hours

**Equivalent Series Resistance ESR :** see item table

**Equivalent Series Inductance ESL :** < 22nH

**Insulation Resistance :** 250Vdc +25C >= 300,000Mohm  
250Vdc+85C >= 50,000Mohm  
250Vdc+105C >= 5,000Mohm

#### Specifications and Size :

P/N	Cap uF	Voltage		dV/dt V/us	Ipeak A	ESR 100kHz 25C m ohm	Max Amp 55C A	Dimension mm +/-1mm W x H x T
		Vdc	Vac					
SMKP2-154X1000DL	0.15	1000	500	800	120	9.1	8.0	45 x 32 x 22
SMKP2-224X1000DL	0.22			800	170	8.5	9.0	45 x 32 x 22
SMKP2-334X1000DL	0.33			800	260	7.6	11	45 x 32 x 22
SMKP2-474X1000DL	0.47			480	220	7.1	12	45 x 32 x 22
SMKP2-564X1000DL	0.56			480	270	6.9	14	45 x 32 x 22
SMKP2-684X1000DL	0.68			480	320	6.3	14	45 x 32 x 22
SMKP2-754X1000DL	0.75			480	360	5.6	15	45 x 32 x 22
SMKP2-105X1000DL	1.0			480	480	4.4	17	51 x 36 x 25
SMKP2-125X1000DL	1.2			480	570	3.6	19	51 x 36 x 25
SMKP2-155X1000DL	1.5			480	720	2.7	21	51 x 40 x 30
SMKP2-205X1000DL	2.0			320	640	2.5	25	59 x 45 x 35
SMKP2-225X1000DL	2.2			320	700	2.4	27	59 x 45 x 35
SMKP2-305X1000DL	3.0			320	960	2.2	29	59 x 45 x 35

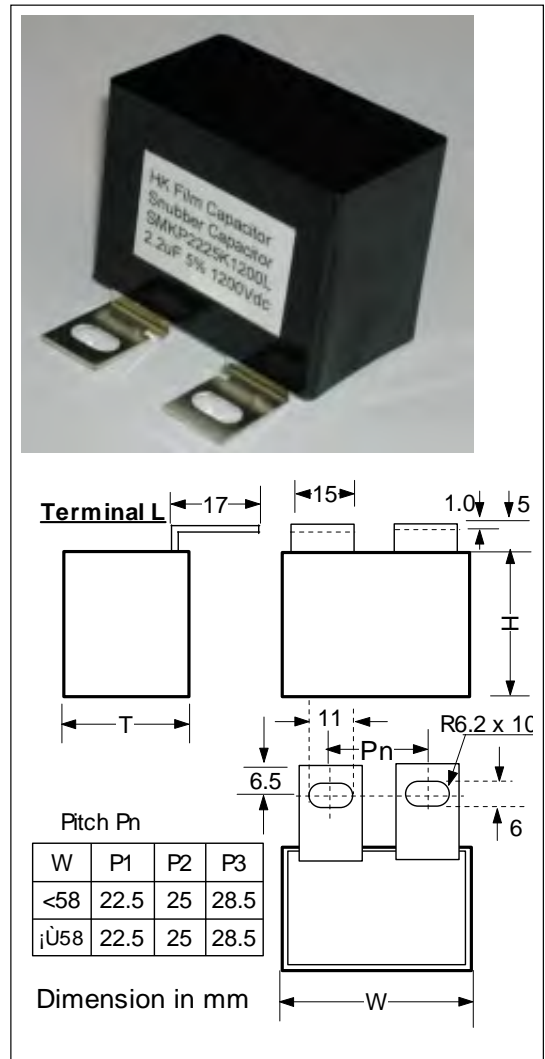

For other Capacitance, Voltage, dv/dt, Peak Current and RMS Current not listed, please contact us for a suggestion.

## Specifications and Size

P/N	Cap	Voltage		dV/dt	Ipeak	ESR 100kHz 25C	Max Amp 55C	Dimension mm +/-1mm
	uF	Vdc	Vac	V/us	A	m ohm	A	W x H x T
SMKP2-154X1200DL	0.15	1200	550	900	130	9.1	8	45 x 32 x 22
SMKP2-224X1200DL	0.22			900	200	8.5	11	45 x 32 x 22
SMKP2-334X1200DL	0.33			900	300	7.6	11	45 x 32 x 22
SMKP2-474X1200DL	0.47			550	250	7.1	13	45 x 32 x 22
SMKP2-564X1200DL	0.56			550	300	6.9	14	45 x 32 x 22
SMKP2-684X1200DL	0.68			550	370	6.3	15	45 x 32 x 22
SMKP2-754X1200DL	0.75			550	410	5.6	17	51 x 36 x 25
SMKP2-105X1200DL	1.0			550	550	4.4	18	51 x 36 x 25
SMKP2-125X1200DL	1.2			550	660	3.6	21	51 x 40 x 30
SMKP2-155X1200DL	1.5			550	820	2.7	23	51 x 40 x 30
SMKP2-205X1200DL	2.0			350	700	2.5	28	59 x 45 x 35
SMKP2-225X1200DL	2.2			350	770	2.4	29	59 x 45 x 35
SMKP2-305X1200DL	3.0			350	1000	2.1	32	59 x 45 x 35
SMKP2-104X1600DL	0.1			1600	630	1000	100	10
SMKP2-154X1600DL	0.15	1000	150			8	11	45 x 32 x 22
SMKP2-224X1600DL	0.22	1000	220			7.5	13	45 x 32 x 22
SMKP2-334X1600DL	0.33	800	260			7.0	14	51 x 36 x 25
SMKP2-474X1600DL	0.47	800	370			6.6	16	51 x 36 x 25
SMKP2-564X1600DL	0.56	800	450			6.2	18	58 x 37 x 32
SMKP2-684X1600DL	0.68	800	540			6.0	19	58 x 37 x 32
SMKP2-754X1600DL	0.75	500	370			5.8	20	58 x 37 x 32
SMKP2-105X1600DL	1.0	500	500			3.2	24	58 x 37 x 32
SMKP2-125X1600DL	1.2	500	600			2.8	25	59 x 45 x 35
SMKP2-104X2000DL	0.1	2000	650			1100	110	8
SMKP2-154X2000DL	0.15			1100	160	7.5	11	45 x 32 x 22
SMKP2-224X2000DL	0.22			850	180	7	14	45 x 32 x 22
SMKP2-334X2000DL	0.33			850	280	6.4	17	51 x 36 x 25
SMKP2-474X2000DL	0.47			850	400	6	19	51 x 40 x 30
SMKP2-564X2000DL	0.56			600	330	5.5	21	58 x 37 x 32
SMKP2-684X2000DL	0.68			600	400	5.0	24	59 x 45 x 35
SMKP2-754X2000DL	0.75			600	450	4.2	25	59 x 45 x 35

Where X is for Capacitance tolerance : J for +/-5%, K for +/-10% and M for +/-20%

For other Capacitance, Voltage, dv/dt, Peak Current and RMS Current not listed, please contact us for a suggestion.

### 3.5.2 High Voltage IGBT Snubber Capacitors

#### SMKP2-N series

##### Applications :

For protection against voltage and current transients in IGBT modules and applications where high dv/dt is encountered

##### Construction :

- Low inductance construction
- Flame retardant plastic case and Epoxy Resin UL94-V0
- High Current carrying capacity Tinned Terminals for direct mounting the capacitor to IGBT module
- other Terminals also available

##### Electrical Characteristics :

Capacitance : 0.056uF – 0.75uF at 1kHz +25C

Capacitance Tolerance : +/-5%(J), +/-10% (K)

Rated Voltage : Ur

Vac	850	1000	1200	1300
Vdc	1700	2000	2500	3200

**Test Voltage** : between Terminals :1.6xUr Vdc 60s +85C / +105C  
Terminals to Case: 3kVac 60s at +25C / +105C

**Ripple RMS Current** : up to 17A

**Rated Temperature** : +70C / +85C / +105C

**Service Life** : 30,000 hours at rated Vac 70C  
60,000 hours at rated Vdc 70C

**Accelerated Life** : 1.25 x rated Vac at 85C for 3,000 hours  
1.25 x rated Vac at 105C for 2,000 hours

**Equivalent Series Resistance ESR** : see item table  
Support Ultra Low ESR requirement

**Equivalent Series Inductance ESL** : < 22nH

**Insulation Resistance** : 250Vdc +25C >= 300,000Mohm  
250Vdc+85C >= 50,000Mohm  
250Vdc+105C >= 5,000Mohm



**Terminal N**

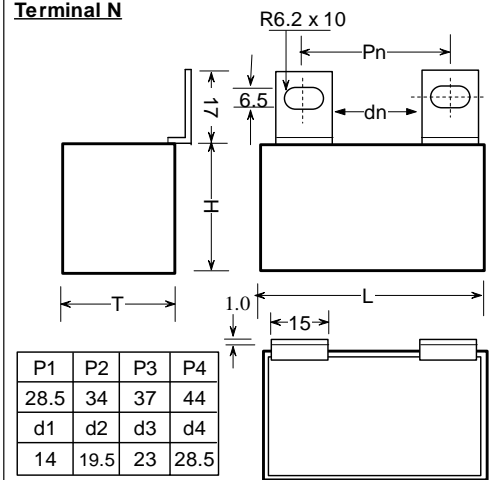

#### Specifications and Size :

**SMKP2-N : Vac = 850Vac / Vndc = 1700Vdc / Vpeak = 1100V 10s / Vsurge = 2750V 30s/day**

P/N :	Cn uF	Width W mm	Height H mm	Thickess L mm	dv/dt v/us	Peak Current I <sub>p-p</sub> A	ESL nH	ESR (mohm) 100KHz	Max. Amp 70C	Max. Amp 85C	Max. Amp 105C
SMKP2-254K850AN	0.25	59	47	39	1800	450	12	3.6	11	9	7
SMKP2-354K850AN	0.3	59	47	39	1800	540	12	3.6	13	11	9
SMKP2-334K850AN	0.33	59	47	39	1800	594	12	3.2	15	13	10
SMKP2-474K850AN	0.47	59	47	39	1800	846	12	2.8	15	13	10
SMKP2-564K850AN	0.56	59	55	45	1080	604	16.5	2.8	15	13	10
SMKP2-684K850AN	0.68	59	55	45	1080	734	16.5	2.4	17	15	12
SMKP2-754K850AN	0.75	59	55	45	1080	810	16.5	2.4	17	15	12

**SMKP2-N : Vac = 1000Vac / Vndc = 2000Vdc / Vpeak = 1250V 10s / Vsurge = 3200V 30s/day**

P/N :	Cn uF	Width W mm	Height H mm	Thickess L mm	dv/dt v/us	Peak Current I <sub>p-p</sub> A	ESL nH	ESR (mohm) 100KHz	Max. Amp 70C	Max. Amp 85C	Max. Amp 105C
SMKP2-154K1000AN	0.15	59	47	39	2800	420	12	4.0	9	8	6
SMKP2-204K1000AN	0.2	59	47	39	2800	560	12	4.0	12	11	8
SMKP2-224K1000AN	0.22	59	47	39	2800	616	12	4.0	12	11	8
SMKP2-254K1000AN	0.25	59	47	39	2800	700	12	3.6	15	13	10
SMKP2-334K1000AN	0.33	59	55	45	1680	554	16.5	3.2	12	11	8
SMKP2-474K1000AN	0.47	59	55	45	1680	789	16.5	2.8	16	14	11

For other Capacitance, Voltage, dv/dt, Peak Current and RMS Current not listed, please contact us for a suggestion.

**SMKP2-N : Vac = 1200Vac / Vndc = 2500Vdc / Vpeak = 1500V 10s / Vsurge = 4000V 30s/day**

P/N :	Cn uF	Width W mm	Height H mm	Thickness L mm	dv/dt v/us	Peak Current I <sub>p-p</sub> A	ESL nH	ESR (mohm) 100KHz	Max. Amp 70C	Max. Amp 85C	Max. Amp 105C
SMKP2-104K1200AN	0.1	59	47	39	4000	400	12	3.6	8	7	5
SMKP2-124K1200AN	0.12	59	47	39	4000	480	12	3.2	8	7	5
SMKP2-154K1200AN	0.15	59	47	39	4000	600	12	3.2	11	9	7
SMKP2-224K1200AN	0.22	59	55	45	2400	528	16.5	3.2	11	9	7
SMKP2-254K1200AN	0.25	59	55	45	2400	600	16.5	2.8	11	9	7
SMKP2-334K1200AN	0.33	59	55	45	2400	792	16.5	2.8	15	13	11

**SMKP2-N : Vac = 1300Vac / Vndc = 3200Vdc / Vpeak = 1600V 10s / Vsurge = 5100V 30s/day**

P/N :	Cn uF	Width W mm	Height H mm	Thickness L mm	dv/dt v/us	Peak Current I <sub>p-p</sub> A	ESL nH	ESR (mohm) 100KHz	Max. Amp 70C	Max. Amp 85C	Max. Amp 105C
SMKP2-563K1300AN	0.056	59	47	39	6180	346	12	5.2	5	4	3
SMKP2-683K1300AN	0.068	59	47	39	6180	420	12	4.8	6	5	4
SMKP2-104K1300AN	0.1	59	47	39	6180	618	12	4.0	9	8	6
SMKP2-124K1300AN	0.12	59	47	39	6180	740	12	4.0	11	10	7
SMKP2-154K1300AN	0.15	59	55	45	3720	558	17	3.6	8	8	6
SMKP2-224K1300AN	0.22	59	55	45	3720	818	17	3.6	12	11	8

For other Capacitance, Voltage, dv/dt, Peak Current and RMS Current not listed, please contact us for a suggestion.

### 3.6 High dv/dt Axial lead Polypropylene Film Capacitors

#### Snubber Capacitors Axial Lead STP-01Q STP-01QE

##### Applications :

- Protecting Thyristor against transient voltage and current
- high dv/dt and Pulse Current applications
- SMPS Snubber Capacitor in SMPS Snubbing circuit
- Switching Mode Power Supply
- MMC Capacitors / Multi-Mini Capacitors module

##### Constructions :

- Axial Lead with Epoxy Resin (UL94-V0)sealed at both ends
- tin plated Copper Wire for PCB soldering
- STP-01QE can have Terminals at the Electrical Wire

##### Electrical Characteristics :

**Capacitance :** 0.01uF - 4.7uF at 1kHz +25C

**Capacitance Tolerance :** +/-5%(J), +/-10% (K)

##### Voltage Range :

600 Vdc	850 Vdc	1000 Vdc	1200 Vdc	1600 Vdc	2000 Vdc	3000 Vdc
275 Vac	450 Vac	500 Vac	500 Vac	630 Vac	630 Vac	750 Vac

**Test Voltage :** between Terminals :1.6xUn Vdc for 60s +25C

**Dissipation Factor :** < 0.1% at 1kHz +25C

**Rated Temperature :** -20C - +85C

Full rated voltage at 85C, derate linearly to 50% rated voltage at 105C.

**Service Life :** 30,000 hours at rated Vac 70C

60,000 hours at rated Vdc 70C

##### Accelerated Life :

1.25 x rated DC voltage at 85C for 2,000 hours

**Insulation Resistance :** >100,000Mohm\*uF

at +25C 100Vdc 2minute.



##### Construction :

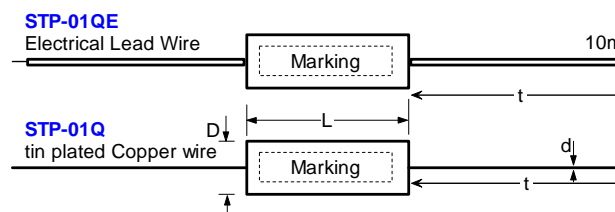
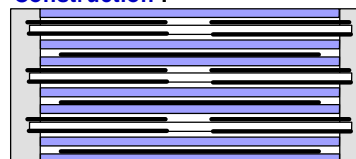

#### STP-01Q Specifications and Size : 600Vdc / 275Vac

Cn uF	Length Mm	Diameter mm	Copper Wire d mm	ESR mohm	ESL nH	dv/dt v/us	Ipeak 70C	Max. Amp 70C
0.10	34.0	9.0	0.8	28	19	195	19.5	2.0
0.15	34.0	10.5	1.0	13	20	195	29	4.0
0.22	34.0	11.5	1.0	12	20	195	43	4.0
0.33	34.0	13.5	1.0	9	21	195	64	5.0
0.47	34.0	15.5	1.0	7	22	195	91	7.0
0.68	34.0	18.0	1.0	6	23	195	132	8.0
1.00	34.0	21.0	1.0	6	24	195	195	9.0
1.50	34.0	25.0	1.2	5	26	195	293	10.0
2.00	46.0	23.5	1.2	5	31	128	256	11.0
3.30	54.0	27.0	1.2	4	36	105	346	15.0
4.70	54.0	32.5	1.2	4	38	105	490	16.0

#### STP-01Q Specifications and Size : 850Vdc / 450Vac

Cn uF	Length Mm	Diameter mm	Copper Wire d mm	ESR mohm	ESL nH	dv/dt v/us	Ipeak 70C	Max. Amp 70C
0.15	34.0	13.0	1.0	8	21	710	106	5.0
0.22	34.0	15.5	1.0	8	22	710	156	6.0
0.33	34.0	18.0	1.0	7	23	710	234	7.0
0.47	34.0	21.0	1.0	5	24	710	333	9.0
0.68	34.0	24.5	1.2	4	26	710	483	12.0
1.0	46.0	22.5	1.2	5	30	400	400	11.0
1.5	46.0	27	1.2	4	32	400	600	14.0
2.0	46.0	31	1.2	3	34	400	800	17.0
2.2	46.0	32	1.2	3	34	400	880	18.0
2.5	46.0	34	1.2	3	35	400	1000	19.0

For other Capacitance, Voltage, dv/dt, Peak Current and RMS Current not listed, please contact us for a suggestion.

Headquarter & Production : HK Film Capacitor Ltd

Worldwide Sales Office : HKFC Industrial Pty Ltd

https://www.hkfc-industrial.com email : enquiry@hkfc-industrial.com

**STP-01Q Specifications and Size : 1000Vdc / 500Vac**

Cn uF	Length Mm	Diameter mm	Copper Wire d mm	ESR mohm	ESL nH	dv/dt v/us	Ipeak 70C	Max. Amp 70C
0.15	34.0	15.0	1.0	7	22	855	128	6.0
0.22	34.0	17.5	1.0	7	23	855	188	7.0
0.33	34.0	21.0	1.0	6	24	855	280	9.0
0.47	34.0	24.0	1.2	5	26	855	400	10.0
0.68	34.0	28.0	1.2	5	27	855	580	11.0
1.0	46.0	26.0	1.2	5	32	480	480	12.0
1.5	46.0	31.0	1.2	4	34	480	720	15.0
2.0	46.0	36.0	1.2	3	36	480	960	19.0

**STP-01Q Specifications and Size : 1200Vdc / 500Vac**

Cn uF	Length Mm	Diameter mm	Copper Wire d mm	ESR mohm	ESL nH	dv/dt v/us	Ipeak 70C	Max. Amp 70C
0.10	34.0	15.5	1.0	9	22	1140	114	6.0
0.15	34.0	18.5	1.0	7	23	1140	170	7.0
0.22	34.0	22.0	1.0	7	24	1140	250	8.0
0.33	46.0	20.0	1.0	7	29	640	210	9.0
0.47	46.0	23.0	1.2	7	30	640	300	10.0
0.68	46.0	27.0	1.2	6	32	640	435	11.0
1.0	46.0	33.0	1.2	5	35	640	640	14.0
1.5	54.0	35.0	1.2	4	39	500	750	18.0

**STP-01Q Specifications and Size : 1600Vdc / 630Vac**

Cn uF	Length Mm	Diameter mm	Copper Wire d mm	ESR mohm	ESL nH	dv/dt v/us	Ipeak 70C	Max. Amp 70C
0.10	34.0	18.0	1.0	7	25	1425	140	7.0
0.15	34.0	22.0	1.0	5	24	1425	210	10
0.22	34.0	26.0	1.2	7	26	1425	310	9.0
0.33	46.0	24.0	1.2	7	31	800	260	10.0
0.47	46.0	28.0	1.2	6	32	800	375	11.0
0.68	46.0	33.0	1.2	6	35	800	540	13.0
1.00	46.0	39.0	1.2	5	37	800	800	16.0
1.50	54.0	42.0	1.2	4	42	625	940	20.0
2.00	64.0	43.0	1.2	3	45	470	940	21.0

**STP-01Q Specifications and Size : 2000Vdc / 630Vac**

Cn uF	Length Mm	Diameter mm	Copper Wire d mm	ESR mohm	ESL nH	dv/dt v/us	Ipeak 70C	Max. Amp 70C
0.022	34.0	12	1.0	35	6	1710	37	2.0
0.033	34.0	14	1.0	20	21	1710	56	3.0
0.047	34.0	15	1.0	12	22	1710	80	5.0
0.068	34.0	18	1.0	8	23	1710	116	6.0
0.10	34.0	21	1.0	7	24	1710	170	8.0
0.15	46.0	20	1.0	7	29	960	141	8.0
0.22	46.0	22	1.0	8	30	960	210	9.0
0.33	46.0	27	1.2	8	32	960	316	10.0
0.47	46.0	32	1.2	6	34	960	451	13.0
0.56	54.0	31	1.2	7	37	754	420	12.0
0.68	54.0	34	1.2	6	39	754	512	14.0
1.00	54.0	41	1.2	5	42	754	750	17.0
1.50	54.0	47	1.2	5	50	754	450	14.0

**STP-01Q Specifications and Size : 3000Vdc / 750Vac**

Cn uF	Length Mm	Diameter mm	Copper Wire d mm	ESR mohm	ESL nH	dv/dt v/us	Ipeak 70C	Max. Amp 70C
0.01	34.0	12	1.0	60	20	2500	25	2.0
0.015	34.0	14	1.0	40	21	2500	38	2.0
0.022	34.0	16	1.0	25	22	2500	56	3.0
0.033	34.0	18	1.0	14	23	2500	84	5.0
0.047	46.0	17	1.0	14	28	1440	67	5.0
0.068	46.0	19	1.0	12	29	1440	98	6.0
0.10	46.0	23	1.2	10	30	1440	140	8.0
0.15	46.0	27	1.2	8	32	1440	210	10.0

For other Capacitance, Voltage, dv/dt, Peak Current and RMS Current not listed, please contact us for a suggestion.

### 3.7 Power RC Snubber Networks : - STRC series

#### Applications :

Interference suppression; elimination of spark and transient phenomena in power switch and relay; arc suppressing for industrial heavy duty application; electrical automation control, starting, stopping, regulating or protecting electric motors  
Transient and dV/dt suppression for power Thyristor and Triacs in snubber circuit  
Fan Speed Regulator and Motor Speed Regulator  
Suitable for AC and DC voltage application

#### Constructions :

Supporting different Capacitor Configuration, electrical connections and mounting options so as to increase your design flexibility

#### Mounting systems :

Cylindrical Plastic Case : with Stud - M8 or without Stud (see P.30)

Box Plastic Case: Screw mounting hole / without Screw mounting hole(see p.33)

#### Electrical Characteristics :

Capacitance value : 0.1 - 2.0uF

Voltage : 125Vac, 220Vac, 240Vac, 480Vac, 600Vac

Resistance and rate power of the Resistor : customer design, 1/4W - 50W

Temperature range : +85C / +105C

Testing Voltage : : 1.5 x U<sub>n</sub> 10sec (can be customized design)

Varistor options is available

#### Circuits :

connection for Resistor and Capacitor : series, parallel or three phase



The combination of Capacitance value, Voltage, Resistor type, Resistance, Power Rating and Dimension, please contact us for a design suited to your particular needs.

Headquarter & Production : HK Film Capacitor Ltd

Worldwide Sales Office : HKFC Industrial Pty Ltd <https://www.hkfc-industrial.com> email : [enquiry@hkfc-industrial.com](mailto:enquiry@hkfc-industrial.com)



**RC Snubber Networks** :-class X2 250VAC / 600DC

**STRC-X2-series**

- Switch Contact protection
- Interference suppression of contact
- Transient Suppression
- Long life even when subjected to high frequency and over voltage
- Plastic Case & Epoxy Resin – Flame Retardant meet UL94-V0
- Varistor options is available

**Electrical Connection :**

- Flexible wire : UL #1015,105C, AWG#18, 20
- Flexible wire with terminal : Ring, Y or Pin terminal with various size

**General Specifications :**

- Capacitance range** : 0.1 – 1.0uF
- Capacitance tolerance** : +/-5%(J) +/-10% (k)
- Resistance range** : 22 to 680 ohm 0.5W / 1W (normal values E6 series)
- Rated Voltage** : 250VAC / 600VDC (inclusive of the superimposed AC component peak value)
- Temperature range** : +85C / +105C

**Testing Voltage :**

- Terminal to Terminal : 2,000VDC 2sec at 25±5C (can be customer design)
- Terminal to Case : 2,500Vac 2sec at 25±5C

**Insulation Resistance** : > 20,000Mohm

**Reference Standard** : IEC60068-1 DIN40045 40/85/21

**Circuitry** : Resistor and Capacitor in series

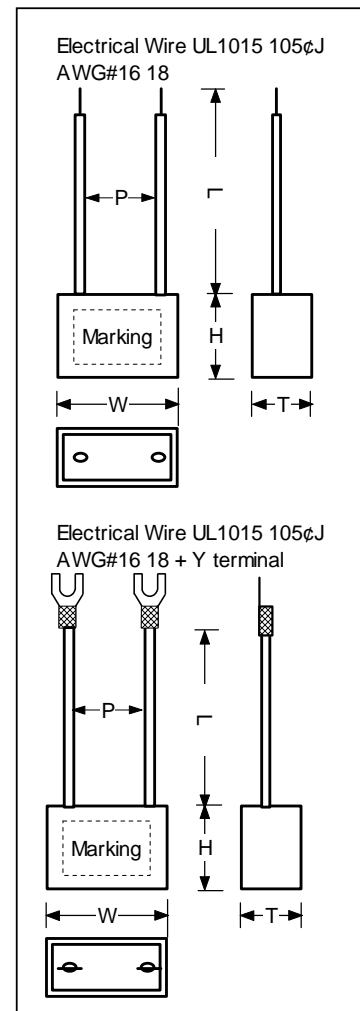

**Dimensions :**

Cn uF +/-10%	Resistance ohm +/-5%	Rated Power W	Rated Voltage		Width W mm	Height H mm	Thickness T mm	Pitch P mm	Lead length L mm
			Vac	Vdc					
0.1	22 – 680	1/2 - 1	250	600	26.5	19	10	21	150 or 300
0.22									
0.25									
0.47					32	22	13	26	
0.5									
1.0									



# RC Snubber Networks :- 480VAC / 1,000DC

STRC-480 series Switch Contact protection  
 Interference suppression of contact  
 Transient Suppression  
 Long life even when subjected to high frequency and over voltage  
 Plastic Case & Epoxy Resin – Flame Retardant meet UL94-V0  
 Varistor options is available

### Electrical Connection :

Flexible wire : UL #1015, 105°C, AWG#18, 20  
 Flexible wire with terminal : Ring, Y or Pin terminal with various size

**Mounting :** M8 stud – Cylindrical type only

### General Specifications :

- Capacitance range** : 0.1 – 1uF
- Capacitance tolerance** : +/-5%(J) +/-10% (k)
- Resistance range** : 22 to 1kohm 1-10W other valve is available
- Rated Voltage** : 480VAC / 1,000VDC (inclusive of the superimposed AC component peak value)
- Temperature range** : +85C / +105C
- Testing Voltage** : T to T : 1.75 x U<sub>n</sub> 10sec at 25 ± 5C (can be customer design)  
 T to Case : 2000Vac 10sec at 25±5C
- Insulation Resistance** : >10,000Mohm at 250VDC 2min. 23C
- Reference Standard** : IEC60068-1

### Circuitry :

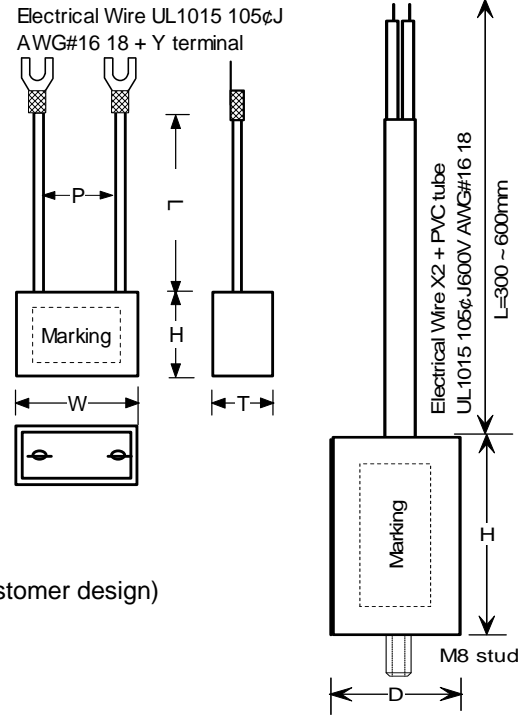
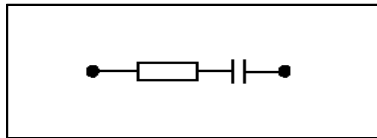

### Box – type :

Cn uF +/-5%	Rated Voltage		Resistance ohm ±10%	Rated Power W	Box			Electrical Wire L=mm
	VAC	VDC			W	H	T	
0.1	480	1000	10	1	39	32	22	300 or 600
0.1	480	1000	22	2				
0.1	480	1000	47	2				
0.1	480	1000	47	1				
0.1	480	1000	100	2				
0.1	480	1000	100	3				
0.1	480	1000	220	1				

### Cylindrical – type :

Cn uF +/-5%	VAC	VDC	ohm ±10%	W	D	H	L=mm
0.22	480	1000	10	5	45	73	300 or 600
0.25	480	1000	220	5			
0.25	480	1000	50	10			
0.25	480	1000	68	10			
0.25	480	1000	100	10			
0.3	480	1000	100	10			
0.47	480	1000	220	5			
0.47	480	1000	820	10			
0.5	480	1000	15	5			
0.5	480	1000	220	5			
0.5	480	1000	10	10			
0.5	480	1000	75	10			
0.5	480	1000	100	10			
0.5	480	1000	220	10			
1.0	480	1000	10	5			
1.0	480	1000	220	5			

### 3 Phase RC Snubber Networks : 400VAC - 600VAC

#### STRCY-xxx and STRCD-xxx series

Applied in parallel with three phase inductive loads (Electrical Motor) to absorb transients Voltage and pulse

EMI filter for Electrical Motor Wye and Delta connection high pulse current handling capacity

Plastic Case & Epoxy Resin – Flame Retardant meet UL94-V0

Varistor options are available

Box and Cylindrical plastic case options

#### Application :

Transient Voltage Suppressor, EMI Filter and Circuit protection for Three phase Motor, CNC equipment, Magnetic Contactor, Solenoid, Relay and Starter

#### Electrical Connection :

Flexible wire : UL #1015,105C, AWG#16, 18

Flexible wire with terminal : Ring, Y or Pin terminal with various size

#### General Specifications :

Capacitance range : 0.1 – 0.5uF

Capacitance tolerance : ±10% (k)

Resistance range : 22 to 820 ohm 3W - other value is available

Rated Voltage : 3 X 400VAC - 600VAC

Temperature range : +85C / +105C

#### Circuitry :

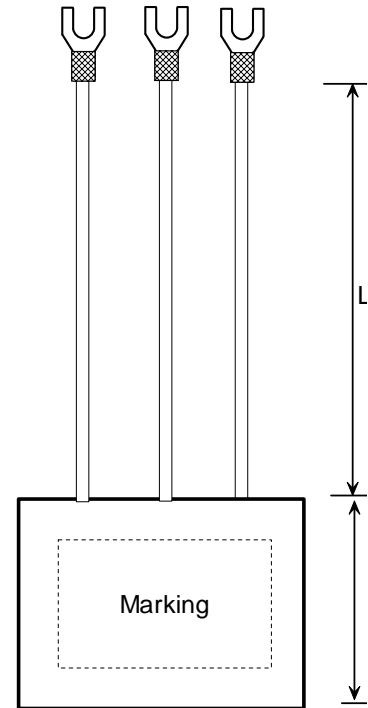
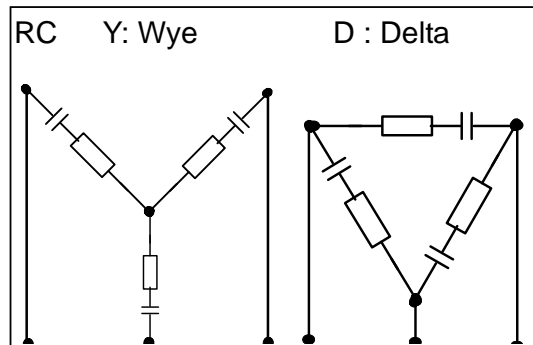

#### Delta :

Cn uF	Voltage	Resistor		Box W X H X T	Electrical Wire L in mm
	VAC	ohm +/-10%	rated power W		
0.1	3X400	10~330	3	42 x 38 x 27	300 or 600
0.22		27~330	3		
0.5		22~470	3		

#### Wye :

Cn uF	Voltage	Resistor		Box W X H X T	Electrical Wire L in mm
	VAC	ohm +/-10%	rated power W		
0.1	3X600	10~330	3	42 x 38 x 27	300 or 600
0.22		27~330	3		
0.5		22~470	3		

### 3 Phase RC Snubber Networks : 480VAC

#### STRCY-xxx and STRCD-xxx series

Applied in parallel with three phase inductive loads (Electrical Motor) to absorb transients Voltage and pulse

EMI filter for Electrical Motor Wye and Delta connection  
 Very High pulse current handling capacity  
 Plastic Case & Epoxy Resin – Flame Retardant meet UL94-V0  
**Varistor** options are available  
 Cylindrical plastic case

#### Application :

Transient Voltage Suppressor, EMI Filter and Circuit protection for Three phase Motor, CNC equipment, Magnetic Contactor, Solenoid, Relay and Starter

#### Electrical Connection :

Flexible wire : UL #1015,105C, AWG#16, 18  
 Flexible wire with terminal : Ring, Y or Pin terminal with various size

#### Mounting :

M8 stud

#### General Specifications :

**Capacitance range** : 10uF ~ 100uF  
**Capacitance tolerance** : +/-5%(J) +/-10%(k)  
**Resistance range** : 10 - 680ohm 10W other value is available  
**Rated Voltage** : 3 X 480VAC  
**Temperature range** : +85C / +105C

#### Circuitry :

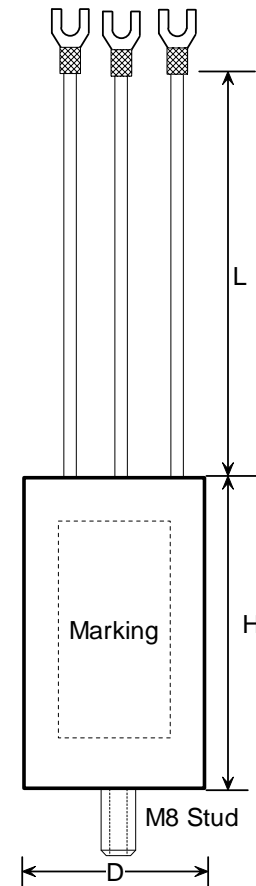
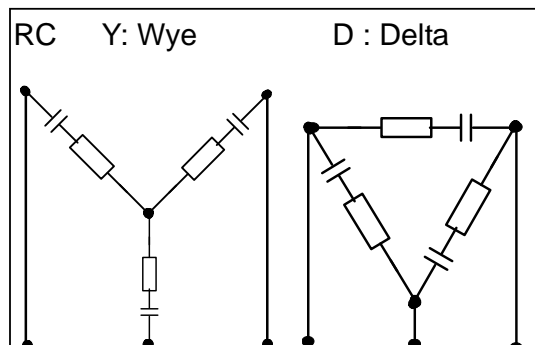

Resistor		Capacitor		Size	Electrical Wire
ohm ±10%	Rated Power W	uF	VAC	D x H mm	L in mm
10	10	0.5	480	45 x 73	300 or 600
15					
22					
27					
33					
47					
68					
82					
100					
150					
220					
330					
470					
680					

## Transient Voltage Suppressors : 24VAC - 480VAC

- STVS-xxx series-Applied in parallel with inductive loads (Electrical Motor) to absorb transients Voltage and pulse
- EMI filter for Electrical Motor
  - High pulse current handling capacity
  - Varistor** options is available
  - Plastic Case & Epoxy Resin – Flame Retardant meet UL94V0
  - Box type and Cylindrical available

### Application :

Transient Voltage Suppressor, EMI Filter and Circuit protection for Three phase Motor, CNC equipment, Magnetic Contactor, Solenoid, Relay and Starter

### Electrical Connection :

- Flexible wire : UL #1015, 105°C, AWG#16, 18
- Flexible wire with terminal : Ring, Y or Pin terminal with various size
- Mounting : M8 stud – Round type only

### General Specifications :

- Capacitance range** : 0.22 – 0.5uF
- Capacitance tolerance** : +/-5%(J) +/-10%(k)
- Resistance range** : 22 to 820ohm 1/2-10W other valve is available
- Rated Voltage** : 24VAC - 480VAC
- Temperature range** : +85C / +105C

### Circuitry :

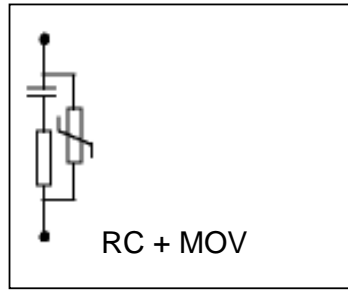

Electrical Wire UL1015 105°CJ  
AWG#16 18 + Y terminal

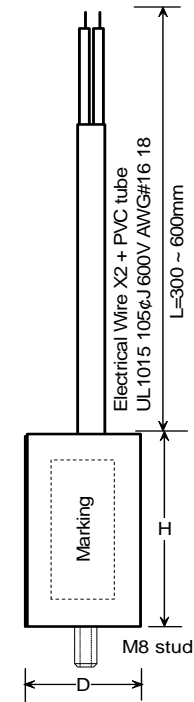
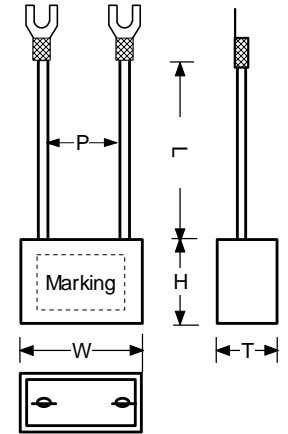

### Dimensions :

Cn uF	Rated Voltage		Resistance		Varistor	Size	Electrical Wire
	VAC	VDC	ohm +/-10%	rated power W		W x H x T D x H	L in mm
0.22	120	200	47	1/2	Customer design	32 x 22 x 11	150 or 300
0.22	250	470	220	1			
0.47	24	50	220	1/2			
0.47	120	600	220	1			
0.5	120	600	100 - 220	1			
0.1	250	1000	47	2			
0.1	275	2000	220	2			
0.47	250	600	100 - 220	2			
0.25	480	1000	470	10			
0.5	480	1000	50 - 220	10		45 x 73	

### 3 Phase Transient Voltage Suppressors : 400VAC - 500VAC

STVSYP-xxx series Applied in parallel with three phase inductive loads (Electrical Motor) to absorb transients Voltage and pulse  
 EMI filter for Electrical Motor  
 Wye connection  
 High pulse current handling capacity  
**Varistor** options is available  
 Plastic Case & Epoxy Resin – Flame Retardant meet UL94-V0  
 Cylindrical type

#### Application :

Transient Voltage Suppressor, EMI Filter and Circuit protection for Three phase Motor, CNC equipment, Magnetic Contactor, Solenoid, Relay and Starter

#### Electrical Connection :

Flexible wire : UL #1015,105C, AWG#16, 18  
 Flexible wire with terminal : Ring, Y or Pin terminal with various size

#### Mounting :

M8 stud

#### General Specifications :

**Capacitance range** : 0.22 – 0.5uF  
**Capacitance tolerance** : +/-5%(J) +/-10% (k)  
**Resistance range** : 22 to 820ohm 1/2-10W other value is available  
**Rated Voltage** : 3 X 250VAC - 510VAC  
**Temperature range** : +70C / +105C

#### Circuitry :

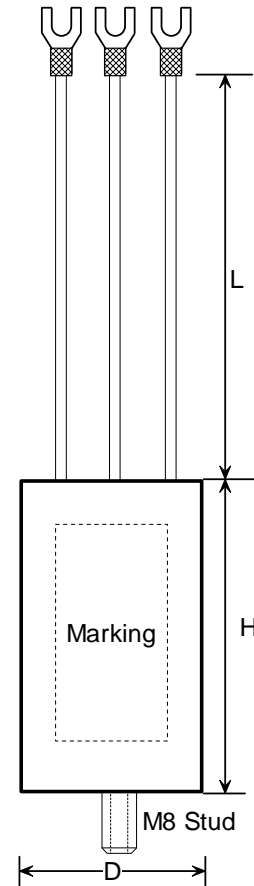
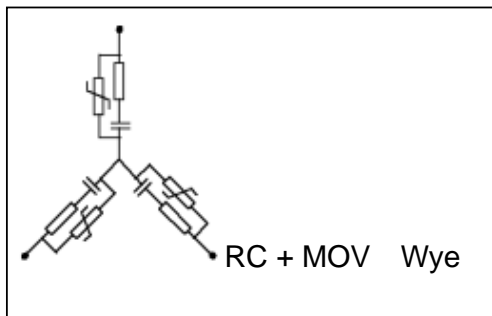

#### Dimensions :

Resistor		Capacitor		Varistor	Size	Electrical Wire
ohm +/-10%	Rated Power W	uF	VAC		D x H mm	L in mm
10~680	10W	0.22	400	Customer design	65 x 50	300 or 600
		0.47	400			
		0.5	500			